

prēmoulē

V285WT  
Jazz Silk  
Textured

R105S - White - Super Matte

## THERMOPLASTIC DOORS AND COMPONENTS

Custom program



## **TABLE OF CONTENTS**

---

**01** DISCOVER OUR THERMOPLASTIC DOOR OPTIONS

### **Door models**

---

**04** SHAKER

**14** SLAB

**16** STANDARD

**30** SPECIAL

### **Customized touch**

---

**35** FRAME AND MULLION DOORS

**37** PANELS, MOULDINGS AND ACCESSORIES

**47** COLORS AND FINISHES

### **Information**

---

**45** TECHNICAL SPECIFICATIONS

**53** WARRANTY



# DISCOVER OUR THERMOPLASTIC DOOR OPTIONS

## 1. SELECT THE PRODUCT

**2XXX** = Door

**4XXX** = Standard frame and mullion doors

**6XXX** = Special frame and mullion doors

**3XXX** = Drawer front

**5XXX** = Panels, mouldings and accessories

## 2. SELECT THE DESIGN

**1** Square

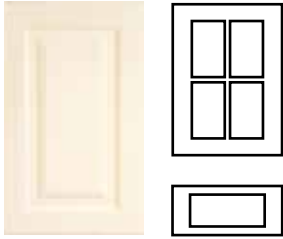

**2** Arch

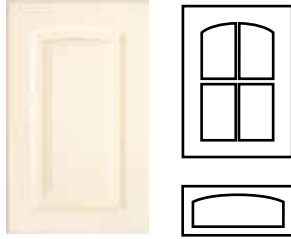

**3** Cathedral

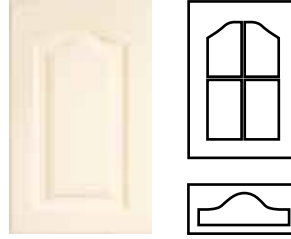

**4** Half Circle

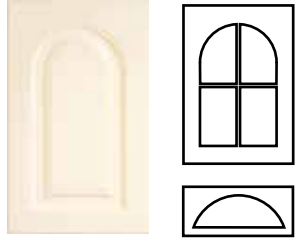

## 3. SELECT THE INTERIOR PROFILE



# DISCOVER OUR THERMOPLASTIC DOOR OPTIONS

## 4. SELECT THE EXTERIOR PROFILE

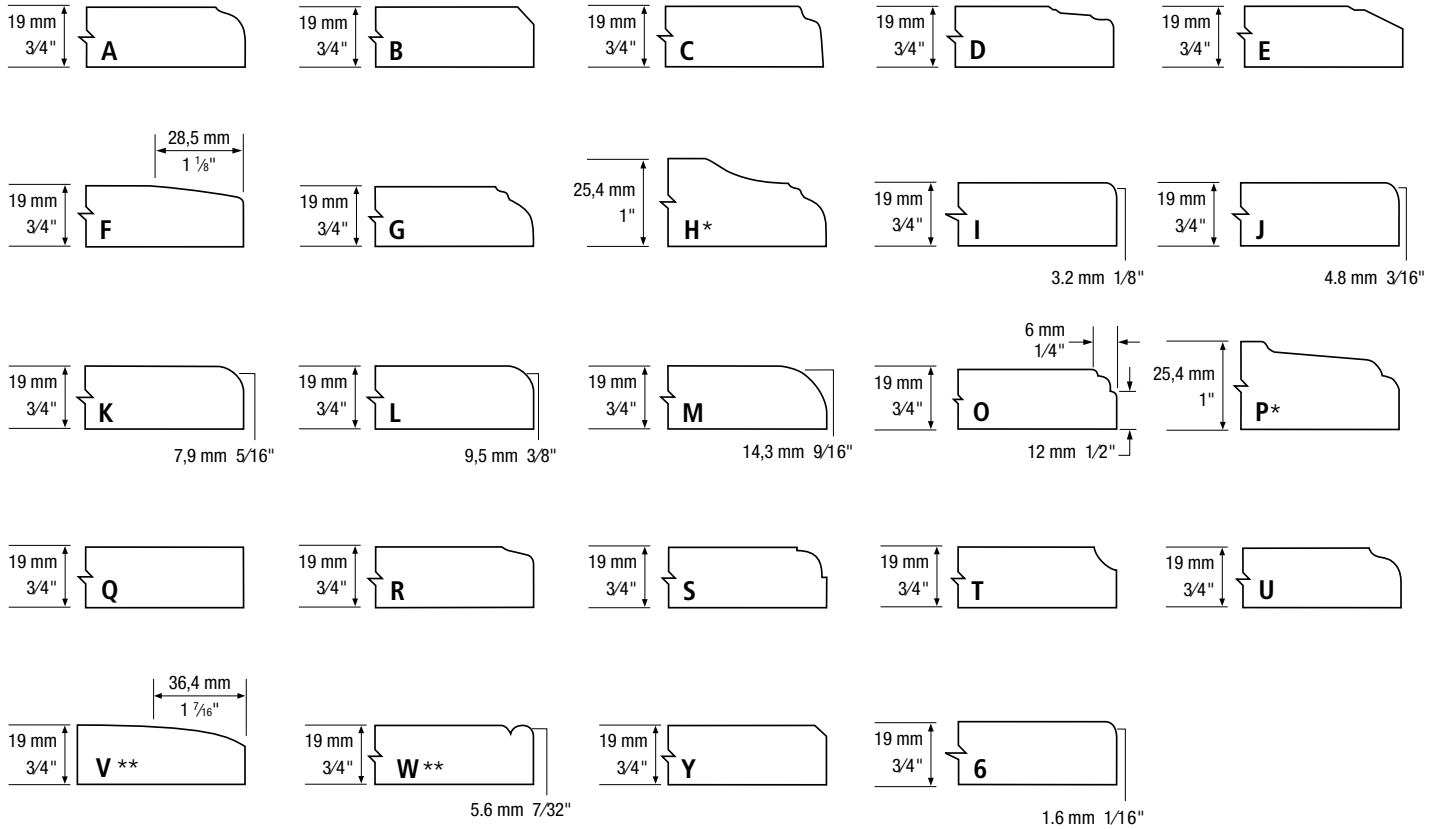

\* Exterior profiles H and P available with MDF 1" only.

\*\* Exterior profiles V and W available with an upcharge.

## 5. THE RESULT

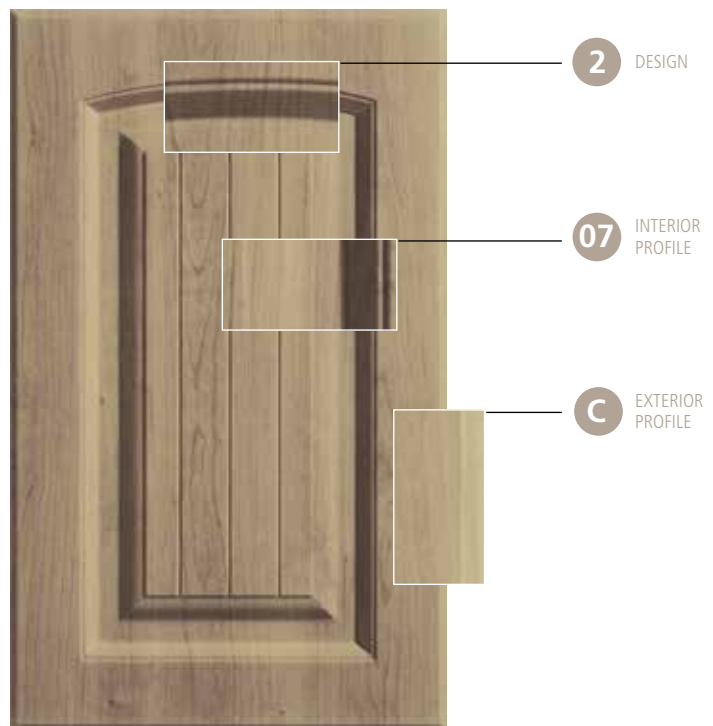

Model **2207**

Color: F435WT

Vertical grooves optional. Details on page 33.



R80S - CELESTINE - SATIN

## DOOR MODELS

SHAKER  
SLAB  
STANDARD  
SPECIAL

# SHAKER MODELS

## OPTION:

- See availability of same color melamine back, pages 47-48.

## SERIES 41 Category 6



Model **2141**  
Color: R82S

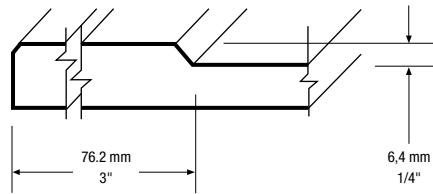

Model **3141**  
Regular rails

Model **3141**  
Reduced rails

### Minimum dimensions

#### Doors and drawer fronts (Height x Width)

| Model     | mm            | inches |
|-----------|---------------|--------|
| 2141/3141 | 177.8 x 177.8 | 7 x 7  |

#### Reduced rails drawer fronts (Height x Width)

| Model   | mm            | inches |
|---------|---------------|--------|
| 3141red | 101.6 x 177.8 | 4 x 7  |

red = reduced rails  
Default exterior profile: Y

Series 41 drawer fronts are manufactured with regular rails. If reduced rails drawer fronts are required, it must be specified when ordering.

## SERIES 42 Category 6



Model **2142**  
Color: A15WT

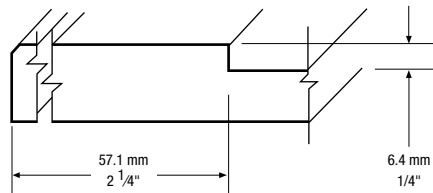

Model **3142**  
Regular rails

Model **3142**  
Reduced rails

### Minimum dimensions

#### Doors and drawer fronts (Height x Width)

| Model     | mm            | inches        |
|-----------|---------------|---------------|
| 2142/3142 | 139.7 x 139.7 | 5 1/2 x 5 1/2 |

#### Reduced rails drawer fronts (Height x Width)

| Model   | mm            | inches    |
|---------|---------------|-----------|
| 3142red | 101.6 x 139.7 | 4 x 5 1/2 |

red = reduced rails  
Default exterior profile: Y

Series 42 drawer fronts are manufactured with regular rails. If reduced rails drawer fronts are required, it must be specified when ordering.



## STANDARD SPECIFICATIONS

- White melamine back
- The default woodgrain direction is vertical

- Shaker drawer fronts are manufactured with regular rails (unless reduced rails are specified)
- Maximum door height: 2438 mm (96"), maximum door width: 1193 mm (47")

## SERIES 51 Cat. 6 / 55 Cat. 6



**Model 2151**  
Color: A15WT

### 51 | Shaker style

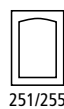
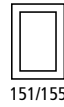
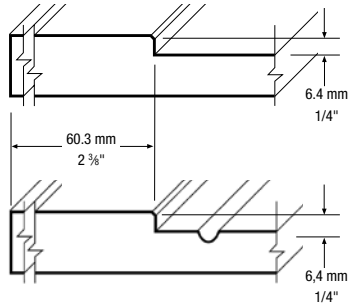

### 55 | Shaker style with grooves

The first groove starts at the center of the door



**Model 3151**  
Regular rails



**Model 3151**  
Reduced rails

### Minimum dimensions

#### Doors and drawer fronts (Height x Width)

| Model               | mm                     | inches                    |
|---------------------|------------------------|---------------------------|
| 2151/2155/3151/3155 | 146.0 x 146.0          | 5 3/4 x 5 3/4             |
| 2251/2255/3251/3255 | 161.0 x 146.0          | 6 11/32 x 5 3/4           |
| 2351/2355/3351/3355 | 186.0 x 200.6          | 7 11/32 x 7 29/32         |
| 2451/2455/3451/3455 | ((W±2) + 99.5) x 146.0 | ((W±2) + 3 15/16) x 5 3/4 |

#### Reduced rails drawer fronts (Height x Width)

| Model        | mm                     | inches                   |
|--------------|------------------------|--------------------------|
| 3151/3155red | 76.2 x 146.0           | 3 x 5 3/4                |
| 3251/3255red | 91.2 x 146.0           | 3 19/32 x 5 3/4          |
| 3351/3355red | 116.2 x 200.6          | 4 9/16 x 7 7/8           |
| 3451/3455red | ((W±2) + 29.7) x 146.0 | ((W±2) + 1 5/32) x 5 3/4 |

red = reduced rails / W = width  
Default exterior profile: Y

Series 51 and 55 drawer fronts are manufactured with regular rails. If reduced rails drawer fronts are required, it must be specified when ordering.

**Model 2155**  
Color: A15WT



**55**  
Category 6

## SERIES 52 Cat. 6 / 56 Cat. 6



**Model 2152**  
Color: R82S

### 52 | Shaker style

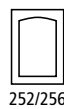
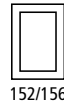
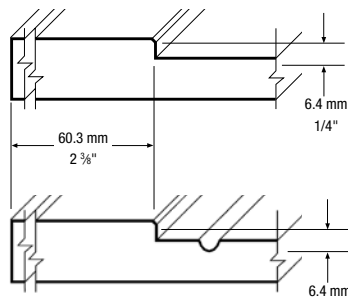

### 56 | Shaker style with grooves

The first groove starts at the center of the door



**Model 3152**  
Regular rails



**Model 3152**  
Reduced rails

### Minimum dimensions

#### Doors and drawer fronts (Height x Width)

| Model               | mm                     | inches                    |
|---------------------|------------------------|---------------------------|
| 2152/2156/3152/3156 | 146.0 x 146.0          | 5 3/4 x 5 3/4             |
| 2252/2256/3252/3256 | 161.0 x 146.0          | 6 11/32 x 5 3/4           |
| 2352/2356/3352/3356 | 186.0 x 200.6          | 7 11/32 x 7 7/8           |
| 2452/2456/3452/3456 | ((W±2) + 99.5) x 146.0 | ((W±2) + 3 29/32) x 5 3/4 |

#### Reduced rails drawer fronts (Height x Width)

| Model        | mm                     | inches                   |
|--------------|------------------------|--------------------------|
| 3152/3156red | 76.2 x 146.0           | 3 x 5 3/4                |
| 3252/3256red | 91.2 x 146.0           | 3 19/32 x 5 3/4          |
| 3352/3356red | 116.2 x 200.6          | 4 9/16 x 7 7/8           |
| 3452/3456red | ((W±2) + 29.7) x 146.0 | ((W±2) + 1 5/32) x 5 3/4 |

red = reduced rails / W = width  
Default exterior profile: Y

Series 52 and 56 drawer fronts are manufactured with regular rails. If reduced rails drawer fronts are required, it must be specified when ordering.

**Model 2156**  
Color: R82S



**56**  
Category 6

# SHAKER MODELS

## OPTION:

- See availability of same color melamine back, pages 47-48.

## SERIES 61 Cat. 6 / 65 Cat. 6



Model **2161**  
Color: K85S

### 61 | Shaker style

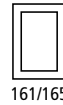
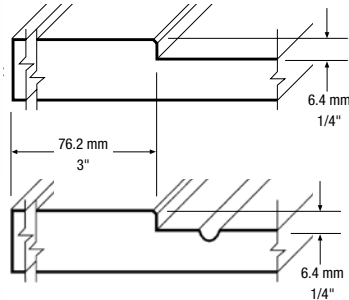

161/165



261/265



361/365



461/465

### 65 | Shaker style with grooves

The first groove starts at the center of the door



Model **3161**  
Regular rails



Model **3161**  
Reduced rails

## Minimum dimensions

### Doors and drawer fronts (Height x Width)

| Model               | mm                                  | inches                           |
|---------------------|-------------------------------------|----------------------------------|
| 2161/2165/3161/3165 | 177.8 x 177.8                       | 7 x 7                            |
| 2261/2265/3261/3265 | 192.8 x 177.8                       | 7 19/32 x 7                      |
| 2361/2365/3361/3365 | 217.8 x 232.4                       | 8 19/32 x 9 5/32                 |
| 2461/2465/3461/3465 | $((W \div 2) + 115.4) \times 177.8$ | $((W \div 2) + 4 9/16) \times 7$ |

### Reduced rails drawer fronts (Height x Width)

| Model        | mm                                 | inches                         |
|--------------|------------------------------------|--------------------------------|
| 3161/3165red | 76.2 x 177.8                       | 3 x 7                          |
| 3261/3265red | 91.2 x 177.8                       | 3 19/32 x 7                    |
| 3361/3365red | 116.2 x 232.4                      | 4 19/32 x 9 5/32               |
| 3461/3465red | $((W \div 2) + 13.8) \times 177.8$ | $((W \div 2) + 9/16) \times 7$ |

red = reduced rails / W = width  
Default exterior profile: Y

Series 61 and 65 drawer fronts are manufactured with regular rails. If reduced rails drawer fronts are required, it must be specified when ordering.

Model **2165**  
Color: K85S



**65**  
Category 6

## SERIES 62 Cat. 6 / 66 Cat. 6



Model **2162**  
Color: V66WT

### 62 | Shaker style

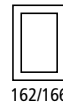
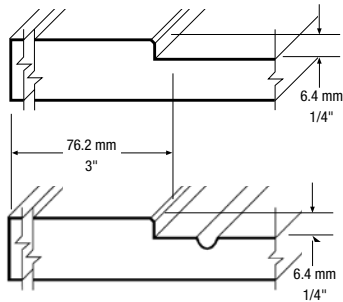

162/166

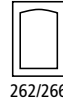

262/266



362/366

### 66 | Shaker style with grooves

The first groove starts at the center of the door



Model **3162**  
Regular rails



Model **3162**  
Reduced rails

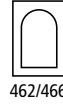

462/466

## Minimum dimensions

### Doors and drawer fronts (Height x Width)

| Model               | mm                                  | inches                           |
|---------------------|-------------------------------------|----------------------------------|
| 2162/2166/3162/3166 | 177.8 x 177.8                       | 7 x 7                            |
| 2262/2266/3262/3266 | 192.8 x 177.8                       | 7 19/32 x 7                      |
| 2362/2366/3362/3366 | 217.8 x 232.4                       | 8 19/32 x 9 5/32                 |
| 2462/2466/3462/3466 | $((W \div 2) + 115.4) \times 177.8$ | $((W \div 2) + 4 9/16) \times 7$ |

### Reduced rails drawer fronts (Height x Width)

| Model        | mm                                 | inches                         |
|--------------|------------------------------------|--------------------------------|
| 3162/3166red | 76.2 x 177.8                       | 3 x 7                          |
| 3262/3266red | 91.2 x 177.8                       | 3 19/32 x 7                    |
| 3362/3366red | 116.2 x 232.4                      | 4 19/32 x 9 5/32               |
| 3462/3466red | $((W \div 2) + 13.8) \times 177.8$ | $((W \div 2) + 9/16) \times 7$ |

red = reduced rails / W = width  
Default exterior profile: Y

Series 62 and 66 drawer fronts are manufactured with regular rails. If reduced rails drawer fronts are required, it must be specified when ordering.

Model **2166**  
Color: V66WT



**66**  
Category 6



## STANDARD SPECIFICATIONS

- White melamine back
- The default woodgrain direction is vertical

- Shaker drawer fronts are manufactured with regular rails (unless reduced rails are specified)
- Maximum door height: 2438 mm (96"), maximum door width: 1193 mm (47")

## SERIES 70 Category 6



Model **2170**  
Color: V66WT

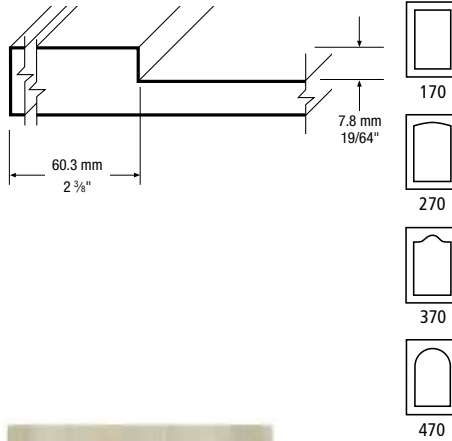

Model **3170**  
Regular rails

Model **3170**  
Reduced rails

### Minimum dimensions

Doors and drawer fronts (Height x Width)

| Model     | mm                                 | inches                                |
|-----------|------------------------------------|---------------------------------------|
| 2170/3170 | 146.0 x 146.0                      | 5 3/4 x 5 3/4                         |
| 2270/3170 | 161.0 x 146.0                      | 6 11/32 x 5 3/4                       |
| 2370/3370 | 186.0 x 200.6                      | 7 11/32 x 7 29/32                     |
| 2470/3470 | $((W \div 2) + 99.5) \times 146.0$ | $((W \div 2) + 3 31/32) \times 5 3/4$ |

Reduced rails drawer fronts (Height x Width)

| Model   | mm                                 | inches                                |
|---------|------------------------------------|---------------------------------------|
| 3170red | 76.2 x 146.0                       | 3 x 5 3/4                             |
| 3270red | 91.2 x 146.0                       | 3 19/32 x 5 3/4                       |
| 3370red | 116.2 x 200.6                      | 4 9/16 x 7 7/8                        |
| 3470red | $((W \div 2) + 29.7) \times 146.0$ | $((W \div 2) + 1 11/64) \times 5 3/4$ |

red = reduced rails / W = width  
Default exterior profile: B

Series 70 drawer fronts are manufactured with regular rails. If reduced rails drawer fronts are required, it must be specified when ordering.

## SERIES 71 Category 6



Model **2171**  
Color: K85S

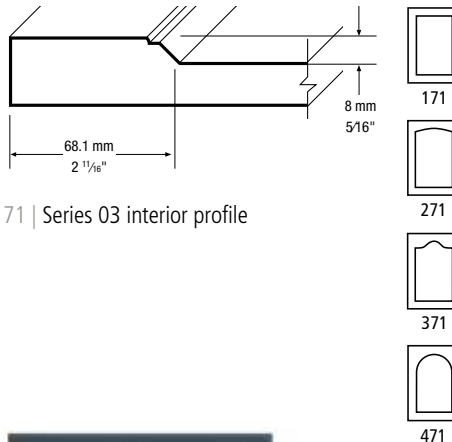

71 | Series 03 interior profile



Model **3171**  
Regular rails

Model **3171**  
Reduced rails

### Minimum dimensions

Doors and drawer fronts (Height x Width)

| Model     | mm                                 | inches                              |
|-----------|------------------------------------|-------------------------------------|
| 2171/3171 | 161.6 x 161.6                      | 6 3/8 x 6 3/8                       |
| 2271/3271 | 176.6 x 161.6                      | 6 31/32 x 6 3/8                     |
| 2371/3371 | 201.6 x 201.8                      | 7 15/16 x 7 31/32                   |
| 2471/3471 | $((W \div 2) + 82.5) \times 161.6$ | $((W \div 2) + 3 1/4) \times 6 3/8$ |

Reduced rails drawer fronts (Height x Width)

| Model   | mm                                 | inches                              |
|---------|------------------------------------|-------------------------------------|
| 3171red | 102.0 x 161.6                      | 4 1/64 x 6 3/8                      |
| 3271red | 117.0 x 161.6                      | 4 39/64 x 6 3/8                     |
| 3371red | 142.0 x 201.8                      | 5 19/32 x 7 31/32                   |
| 3471red | $((W \div 2) + 22.9) \times 161.6$ | $((W \div 2) + 29/32) \times 6 3/8$ |

red = reduced rails / W = width  
Default exterior profile: B

Series 71 drawer fronts are manufactured with regular rails. If reduced rails drawer fronts are required, it must be specified when ordering.

# SHAKER MODELS

## OPTION:

- See availability of same color melamine back, pages 47-48.

## SERIES 72 Category 6



Model **2172**  
Color: A661S

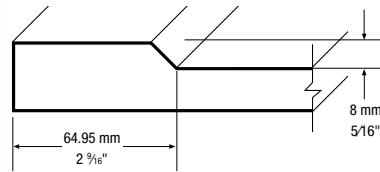

72 | Series 09 interior profile

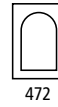

Model **3172**  
Regular rails



Model **3172**  
Reduced rails

### Minimum dimensions

#### Doors and drawer fronts (Height x Width)

| Model     | mm                                 | inches                              |
|-----------|------------------------------------|-------------------------------------|
| 2172/3172 | 155.3 x 155.3                      | 6 1/8 x 6 1/8                       |
| 2272/3272 | 170.3 x 155.3                      | 6 23/32 x 6 1/8                     |
| 2372/3372 | 195.3 x 193.9                      | 7 23/32 x 7 21/32                   |
| 2472/3472 | $((W \div 2) + 79.8) \times 155.3$ | $((W \div 2) + 3 1/8) \times 6 1/8$ |

#### Reduced rails drawer fronts (Height x Width)

| Model   | mm                                 | inches                              |
|---------|------------------------------------|-------------------------------------|
| 3172red | 91.3 x 155.3                       | 3 5/8 x 6 1/8                       |
| 3272red | 106.3 x 155.3                      | 4 3/16 x 6 1/8                      |
| 3372red | 131.3 x 193.9                      | 5 3/16 x 7 21/32                    |
| 3472red | $((W \div 2) + 15.4) \times 155.3$ | $((W \div 2) + 39/64) \times 6 1/8$ |

red = reduced rails / W = width  
Default exterior profile: B

Series 72 drawer front are manufactured with regular rails. If reduced rails drawer fronts are required, it must be specified when ordering.

## SERIES 77 Category 6



Model **2177**  
Color: A4WT

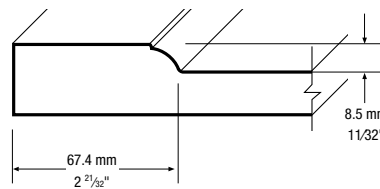

77 | Series 83 interior profile



Model **3177**  
Regular rails



Model **3177**  
Reduced rails

### Minimum dimensions

#### Doors and drawer fronts (Height x Width)

| Model     | mm                                  | inches                                |
|-----------|-------------------------------------|---------------------------------------|
| 2177/3177 | 179.8 x 179.8                       | 7 3/32 x 7 3/32                       |
| 2277/3277 | 194.8 x 179.8                       | 7 11/16 x 7 3/32                      |
| 2377/3377 | 219.8 x 214.8                       | 8 21/32 x 8 15/32                     |
| 2477/3477 | $((W \div 2) + 112.5) \times 179.8$ | $((W \div 2) + 4 7/16) \times 7 3/32$ |

#### Reduced rails drawer fronts (Height x Width)

| Model   | mm                                 | inches                                 |
|---------|------------------------------------|--|
| 3177red | 116.6 x 179.8                      | 4 19/32 x 7 3/32                       |
| 3277red | 131.6 x 179.8                      | 5 3/16 x 7 3/32                        |
| 3377red | 156.6 x 214.8                      | 6 3/16 x 8 15/32                       |
| 3477red | $((W \div 2) + 49.3) \times 179.8$ | $((W \div 2) + 1 31/32) \times 7 3/32$ |

red = reduced rails / W = width  
Default exterior profile: C

Series 77 drawer front are manufactured with regular rails. If reduced rails drawer fronts are required, it must be specified when ordering.

## STANDARD SPECIFICATIONS

- White melamine back
- The default woodgrain direction is vertical

- Shaker drawer fronts are manufactured with regular rails (unless reduced rails are specified)
- Maximum door height: 2438 mm (96"), maximum door width: 1193 mm (47")

## SERIES 78 Category 6



Model **2178**  
Color: A4WT

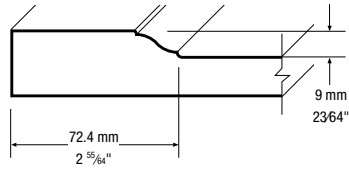

78 | Series 85 interior profile



Model **3178**  
Regular rails



Model **3178**  
Reduced rails



178



278



378



478

### Minimum dimensions

#### Doors and drawer fronts (Height x Width)

| Model     | mm                           | inches                         |
|-----------|------------------------------|--------------------------------|
| 2178/3178 | 189.8 x 189.8                | 7 1/2 x 7 1/2                  |
| 2278/3278 | 204.8 x 189.8                | 8 3/32 x 7 1/2                 |
| 2378/3378 | 229.8 x 224.8                | 9 1/16 x 8 7/8                 |
| 2478/3478 | $(W \div 2) + 117.5$ x 189.8 | $(W \div 2) + 4 21/32$ x 7 1/2 |

#### Reduced rails drawer fronts (Height x Width)

| Model   | mm                          | inches                        |
|---------|-----------------------------|-------------------------------|
| 3178red | 126.6 x 189.8               | 5 x 7 1/2                     |
| 3278red | 141.6 x 189.8               | 5 19/32 x 7 1/2               |
| 3378red | 166.6 x 224.8               | 6 9/16 x 8 7/8                |
| 3478red | $(W \div 2) + 54.3$ x 189.8 | $(W \div 2) + 2 5/32$ x 7 1/2 |

red = reduced rails / W = width  
Default exterior profile: C

Series 78 drawer fronts are manufactured with regular rails. If reduced rails drawer fronts are required, it must be specified when ordering.

## SERIES 79 Category 6



Model **2179**  
Color: A661S

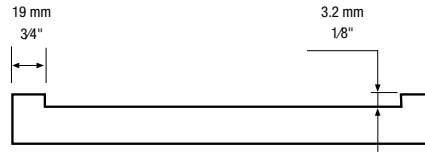

Model **3179**  
Regular rails

### Minimum dimensions

#### Doors and drawer fronts (Height x Width)

| Model     | mm          | inches |
|-----------|-------------|--------|
| 2179/3179 | 76.2 x 76.2 | 3 x 3  |

W = width  
Default exterior profile: Y

Series 79 drawer fronts are manufactured with regular rails. Frame and mullion doors not available in this model. Available exterior profiles: I, J, Q, Y and 6.

# SHAKER MODELS

## OPTION:

- See availability of same color melamine back, pages 47-48.

## SERIES 80 Category 6



Model **2180**  
Color: K464WT

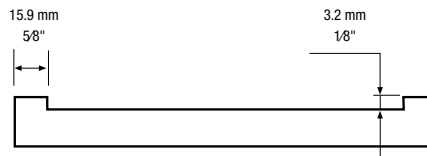

Model **3180**  
Regular rails

### Minimum dimensions

Doors and drawer fronts (Height x Width)

| Model     | mm          | inches |
|-----------|-------------|--------|
| 2180/3180 | 76.2 x 76.2 | 3 x 3  |

W = width

Default exterior profile: Y

Series 80 drawer fronts are manufactured with regular rails. Frame and mullion doors not available in this model. Available exterior profiles: I, J, Q, Y and 6.

## SERIES 942 Category 6



Model **2942**  
Color: K257S

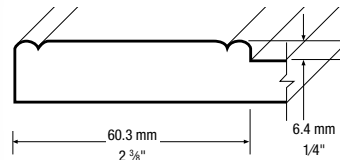

Model **3942**  
Regular rails



Model **3942**  
Reduced rails

### Minimum dimensions

Doors and drawer fronts (Height x Width)

| Model     | mm            | inches        |
|-----------|---------------|---------------|
| 2942/3942 | 146.0 x 146.0 | 5 3/4 x 5 3/4 |

Reduced rails drawer fronts (Height x Width)

| Model   | mm           | inches    |
|---------|--------------|-----------|
| 3942red | 76.2 x 146.0 | 3 x 5 3/4 |

red = reduced rails

Default exterior profile: W

Series 942 drawer fronts are manufactured with regular rails. If reduced rails drawer fronts are required, it must be specified when ordering.

## STANDARD SPECIFICATIONS

- White melamine back
- The default woodgrain direction is vertical
- Shaker drawer fronts are manufactured with regular rails (unless reduced rails are specified)
- Maximum door height: 2438 mm (96"), maximum door width: 1193 mm (47")

### SERIES 64 Category 4



Model **2164**  
Color: K257S

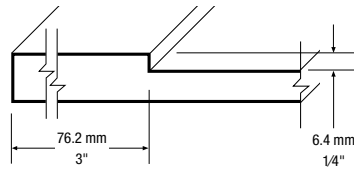

Model **3164**  
Regular rails



Model **3164**  
Reduced rails

#### Minimum dimensions

##### Doors and drawer fronts (Height x Width)

| Model     | mm            | inches |
|-----------|---------------|--------|
| 2164/3164 | 177.8 x 177.8 | 7 x 7  |

##### Reduced rails drawer fronts (Height x Width)

| Model   | mm           | inches |
|---------|--------------|--------|
| 3164red | 76.2 x 177.8 | 3 x 7  |

red = reduced rails

Default exterior profile: Y

Series 64 drawer fronts are manufactured with regular rails. If reduced rails drawer fronts are required, it must be specified when ordering.

### SERIES 67 Category 4



Model **2167**  
Color: K464WT

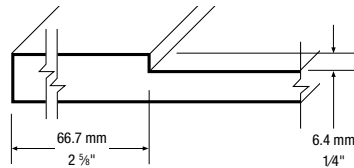

Model **3167**  
Regular rails



Model **3167**  
Reduced rails

#### Minimum dimensions

##### Doors and drawer fronts (Height x Width)

| Model     | mm            | inches        |
|-----------|---------------|---------------|
| 2167/3167 | 158.8 x 158.8 | 6 1/4 x 6 1/4 |

##### Reduced rails drawer fronts (Height x Width)

| Model   | mm           | inches    |
|---------|--------------|-----------|
| 3167red | 76.2 x 158.8 | 3 x 6 1/4 |

red = reduced rails

Default exterior profile: Y

Series 67 drawer fronts are manufactured with regular rails. If reduced rails drawer fronts are required, it must be specified when ordering.

# SHAKER MODELS

## OPTION:

- See availability of same color melamine back, pages 47-48.

## SERIES 764 Category 5



Model **2764**  
Color: R82S

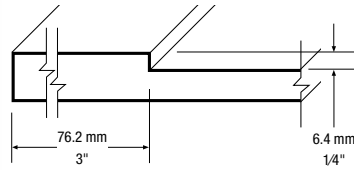

Model **3764**  
Regular rails



Model **3764**  
Reduced rails

### Minimum dimensions

#### Doors and drawer fronts (Height x Width)

| Model     | mm            | inches |
|-----------|---------------|--------|
| 2764/3764 | 177.8 x 177.8 | 7 x 7  |

#### Reduced rails drawer fronts (Height x Width)

| Model   | mm           | inches |
|---------|--------------|--------|
| 3764red | 76.2 x 177.8 | 3 x 7  |

red = reduced rails  
Default exterior profile: Y

Series 764 drawer fronts are manufactured with regular rails. If reduced rails drawer fronts are required, it must be specify when ordering.

## SERIES 767 Category 5



Model **2767**  
Color: A15WT

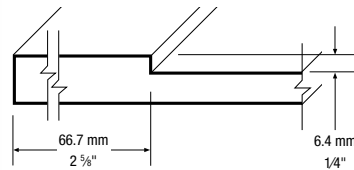

Model **3767**  
Regular rails



Model **3767**  
Reduced rails

### Minimum dimensions

#### Doors and drawer fronts (Height x Width)

| Model     | mm            | inches        |
|-----------|---------------|---------------|
| 2767/3767 | 158.8 x 158.8 | 6 1/4 x 6 1/4 |

#### Reduced rails drawer fronts (Height x Width)

| Model   | mm           | inches    |
|---------|--------------|-----------|
| 3767red | 76.2 x 158.8 | 3 x 6 1/4 |

red = reduced rails  
Default exterior profile: Y

Series 767 drawer fronts are manufactured with regular rails. If reduced rails drawer fronts are required, it must be specify when ordering.



## STANDARD SPECIFICATIONS

- White melamine back
- The default woodgrain direction is vertical
- Shaker drawer fronts are manufactured with regular rails (unless reduced rails are specified)
- Maximum door height: 2438 mm (96"), maximum door width: 1193 mm (47")

## SERIES 945 Category 7



Model **2945**  
Color : A15WT

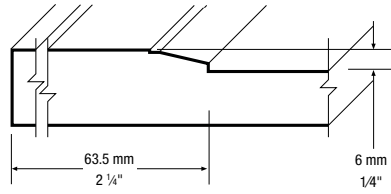

Model **3945**  
Regular rails



Model **3945**  
Reduced rails

### Minimum dimensions

#### Doors and drawer fronts (Height x Width)

| Model     | mm            | inches |
|-----------|---------------|--------|
| 2945/3945 | 152.4 x 152.4 | 6 x 6  |

#### Reduced rails drawer fronts (Height x Width)

| Model   | mm            | inches |
|---------|---------------|--------|
| 2945red | 101.6 x 152.4 | 4 x 6  |

red = reduced rails  
Default exterior profile: Y

Series 945 drawer fronts are manufactured with regular rails. If reduced rails drawer fronts are required, it must be specify when ordering.



C35S - White - Satin

# SLAB MODELS

## OPTION:

- See availability of same color melamine back, pages 47-48.

## SERIES 00 Category 1



Model **2000**  
Color: K85S

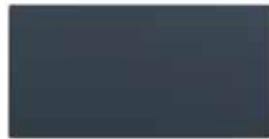
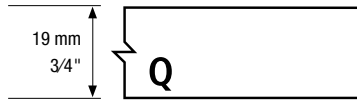

Model **3000**

Minimum dimensions for series 00 vary according to the exterior profile selected:

Doors and drawer fronts (Height x Width)

| Model     | Exterior profile                                     | mm          | inches          |
|-----------|--|-------------|-----------------|
| 2000/3000 | A, B, C, G, I, J, K, L, M, O, Q, R, S, T, U, V, Y, 6 | 38.1 x 38.1 | 1 1/2 x 1 1/2   |
| 2000/3000 | D, E, W  | 50.8 x 50.8 | 2 x 2           |
| 2000/3000 | F  | 76.2 x 76.2 | 3 x 3           |
| 2000/3000 | H  | 82.6 x 82.6 | 3 1/4 x 3 1/4   |
| 2000/3000 | P  | 90.5 x 90.5 | 3 9/16 x 3 9/16 |

Minimum charge of 0.19 sq.m. (2 sq.ft.) for thermoplastic fillers whose height or width is less than 76.2 mm (3") and whose length is greater than 1828 mm (72").

Frame and mullion doors not available in this model.

## SERIES 00 Category 1



Model **2000**  
Color: V66WT

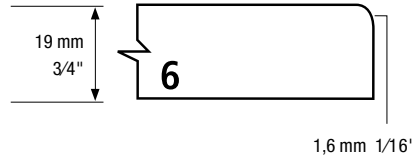

Model **3000**

Minimum dimensions for series 00 vary according to the exterior profile selected:

Doors and drawer fronts (Height x Width)

| Model     | Exterior profile                                     | mm          | inches          |
|-----------|--|-------------|-----------------|
| 2000/3000 | A, B, C, G, I, J, K, L, M, O, Q, R, S, T, U, V, Y, 6 | 38.1 x 38.1 | 1 1/2 x 1 1/2   |
| 2000/3000 | D, E, W  | 50.8 x 50.8 | 2 x 2           |
| 2000/3000 | F  | 76.2 x 76.2 | 3 x 3           |
| 2000/3000 | H  | 82.6 x 82.6 | 3 1/4 x 3 1/4   |
| 2000/3000 | P  | 90.5 x 90.5 | 3 9/16 x 3 9/16 |

Minimum charge of 0.19 sq.m. (2 sq.ft.) for thermoplastic fillers whose height or width is less than 76.2 mm (3") and whose length is greater than 1828 mm (72").

Frame and mullion doors not available in this model.

## STANDARD FEATURES

- White melamine back
- The default woodgrain direction is vertical

- Maximum door height: 2438 mm (96")
- Maximum door width: 1193 mm (47")

## SERIES 00 Category 1



Model **2000**  
Color: V66WT

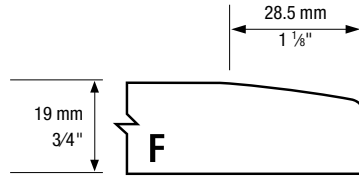

Model **3000**

Minimum dimensions for series 00 vary according to the exterior profile selected:

Doors and drawer fronts (Height x Width)

| Model     | Exterior profile                                     | mm          | inches          |
|-----------|--|-------------|-----------------|
| 2000/3000 | A, B, C, G, I, J, K, L, M, O, Q, R, S, T, U, V, Y, 6 | 38.1 x 38.1 | 1 1/2 x 1 1/2   |
| 2000/3000 | D, E, W  | 50.8 x 50.8 | 2 x 2           |
| 2000/3000 | F  | 76.2 x 76.2 | 3 x 3           |
| 2000/3000 | H  | 82.6 x 82.6 | 3 1/4 x 3 1/4   |
| 2000/3000 | P  | 90.5 x 90.5 | 3 9/16 x 3 9/16 |

Minimum charge of 0.19 sq.m. (2 sq.ft.) for thermoplastic fillers whose height or width is less than 76.2 mm (3") and whose length is greater than 1828 mm (72").

Frame and mullion doors not available in this model.

## SERIES 00 Category 2



Model **2000**  
Color: K85S

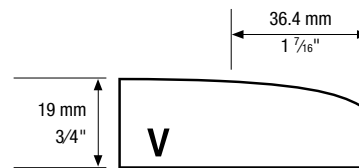

Model **3000**

Minimum dimensions for series 00 vary according to the exterior profile selected:

Doors and drawer fronts (Height x Width)

| Model     | Exterior profile                                     | mm          | inches          |
|-----------|--|-------------|-----------------|
| 2000/3000 | A, B, C, G, I, J, K, L, M, O, Q, R, S, T, U, V, Y, 6 | 38.1 x 38.1 | 1 1/2 x 1 1/2   |
| 2000/3000 | D, E, W  | 50.8 x 50.8 | 2 x 2           |
| 2000/3000 | F  | 76.2 x 76.2 | 3 x 3           |
| 2000/3000 | H  | 82.6 x 82.6 | 3 1/4 x 3 1/4   |
| 2000/3000 | P  | 90.5 x 90.5 | 3 9/16 x 3 9/16 |

Minimum charge of 0.19 sq.m. (2 sq.ft.) for thermoplastic fillers whose height or width is less than 76.2 mm (3") and whose length is greater than 1828 mm (72").

Frame and mullion doors not available in this model.

# STANDARD MODELS

## OPTIONS:

- See availability of same color melamine back, pages 47-48.
- For regular rails drawer fronts, order as a door.

## SERIES 03 Category 4



Model **2103**  
Color: A661S

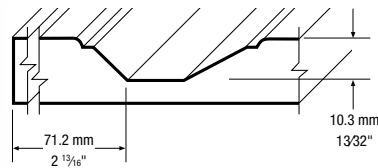

103



203



303



403

### Minimum dimensions

#### Doors (Height x Width)

| Model | mm                                 | inches                              |
|-------|------------------------------------|-------------------------------------|
| 2103  | 225.0 x 225.0                      | 8 7/8 x 8 7/8                       |
| 2203  | 240.0 x 225.0                      | 9 15/32 x 8 7/8                     |
| 2303  | 265.0 x 225.0                      | 10 7/16 x 8 7/8                     |
| 2403  | $((W \div 2) + 82.5) \times 225.0$ | $((W \div 2) + 3 1/4) \times 8 7/8$ |

#### Drawer fronts (Height x Width)

| Model | mm                                | inches                             |
|-------|-----------------------------------|------------------------------------|
| 3103  | 146.4 x 225.0                     | 5 25/32 x 8 7/8                    |
| 3203  | 161.4 x 225.0                     | 6 3/8 x 8 7/8                      |
| 3303  | 186.4 x 225.0                     | 7 11/32 x 8 7/8                    |
| 3403  | $((W \div 2) + 3.9) \times 225.0$ | $((W \div 2) + 5/32) \times 8 7/8$ |

W = width  
Default exterior profile: B



Model **3103**  
Standard models

## SERIES 27 Category 4



Model **2127**  
Color: A4WT

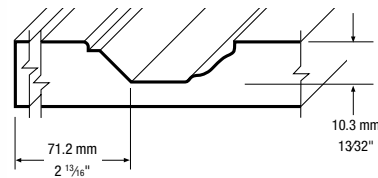

127



227



327



427

### Minimum dimensions

#### Doors (Height x Width)

| Model | mm                                 | inches                                |
|-------|------------------------------------|---------------------------------------|
| 2127  | 208.4 x 208.4                      | 8 2/32 x 8 2/32                       |
| 2227  | 223.4 x 208.4                      | 8 13/16 x 8 2/32                      |
| 2327  | 248.4 x 208.4                      | 9 25/32 x 8 2/32                      |
| 2427  | $((W \div 2) + 81.2) \times 208.4$ | $((W \div 2) + 3 7/32) \times 8 2/32$ |

#### Drawer fronts (Height x Width)

| Model | mm                                | inches                             |
|-------|-----------------------------------|------------------------------------|
| 3127  | 129.8 x 208.4                     | 5 1/8 x 8 2/32                     |
| 3227  | 144.8 x 208.4                     | 5 23/32 x 8 2/32                   |
| 3327  | 169.8 x 208.4                     | 6 11/16 x 8 2/32                   |
| 3427  | $((W \div 2) + 2.6) \times 208.4$ | $((W \div 2) + 1/8) \times 8 2/32$ |

W = width  
Default exterior profile: A



Model **3127**  
Reduced rails

## STANDARD SPECIFICATIONS

- White melamine back
- The default woodgrain direction is vertical

- Drawer fronts are manufactured with reduced rails (unless regular rails are specified)
- Maximum door height: 2438 mm (96"), maximum door width: 1193 mm (47")

## SERIES 49 Category 4



Model **2149**  
Color: A4WT

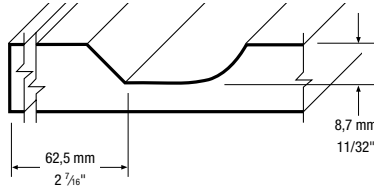

149



249



349



449

### Minimum dimensions

#### Doors (Height x Width)

| Model | mm                   | inches  |
|-------|----------------------|---|
| 2149  | 195.6 x 195.6        | 7 <sup>23</sup> / <sub>32</sub> x 7 <sup>23</sup> / <sub>32</sub>           |
| 2249  | 210.6 x 195.6        | 8 <sup>5</sup> / <sub>16</sub> x 7 <sup>23</sup> / <sub>32</sub>            |
| 2349  | 238.6 x 220.0        | 9 <sup>13</sup> / <sub>32</sub> x 8 <sup>11</sup> / <sub>16</sub>           |
| 2449  | ((W÷2) + 77) x 195.6 | ((W÷2) + 3 <sup>1</sup> / <sub>16</sub> ) x 7 <sup>23</sup> / <sub>32</sub> |

#### Drawer fronts (Height x Width)

| Model | mm                   | inches   |
|-------|----------------------|--|
| 3149  | 139.6 x 195.6        | 5 <sup>1</sup> / <sub>2</sub> x 7 <sup>23</sup> / <sub>32</sub>            |
| 3249  | 154.6 x 195.6        | 6 <sup>3</sup> / <sub>32</sub> x 7 <sup>23</sup> / <sub>32</sub>           |
| 3349  | 185.6 x 220.0        | 7 <sup>5</sup> / <sub>16</sub> x 8 <sup>11</sup> / <sub>16</sub>           |
| 3449  | ((W÷2) + 21) x 195.6 | ((W÷2) + <sup>27</sup> / <sub>32</sub> ) x 7 <sup>23</sup> / <sub>32</sub> |

W = width  
Default exterior profile: C



Model **3149**  
Reduced rails

## SERIES 50 Cat. 2 / 40 Cat. 2



Model **2150**  
Color: A661S

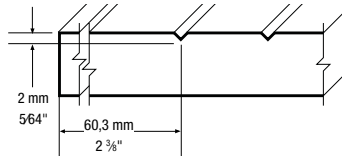

50 | Standard style with grooves

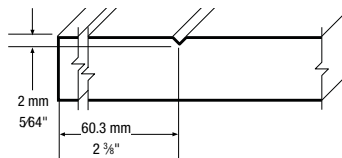

40 | Standard style



150



250



350



450



Model **3150**  
Regular rails



Model **3150**  
Reduced rails

### Minimum dimensions

#### Doors and drawer fronts (Height x Width)

| Model               | mm                     | inches   |
|---------------------|------------------------|--|
| 2150/2140/3150/3140 | 146.0 x 146.0          | 5 <sup>3</sup> / <sub>4</sub> x 5 <sup>3</sup> / <sub>4</sub>              |
| 2250/2240/3250/3240 | 161.0 x 146.0          | 6 <sup>11</sup> / <sub>32</sub> x 5 <sup>3</sup> / <sub>4</sub>            |
| 2350/2340/3350/3340 | 186.0 x 200.6          | 7 <sup>11</sup> / <sub>32</sub> x 7 <sup>29</sup> / <sub>32</sub>          |
| 2450/2440/3450/3440 | ((W÷2) + 60.4) x 146.0 | ((W÷2) + 2 <sup>13</sup> / <sub>32</sub> ) x 5 <sup>3</sup> / <sub>4</sub> |

#### Reduced rails drawer fronts (Height x Width)

| Model        | mm                    | inches   |
|--------------|-----------------------|--|
| 3150/3140red | 76.2 x 146.0          | 3 x 5 <sup>3</sup> / <sub>4</sub>                                      |
| 3250/3240red | 91.2 x 146.0          | 3 <sup>19</sup> / <sub>32</sub> x 5 <sup>3</sup> / <sub>4</sub>        |
| 3350/3340red | 116.2 x 200.6         | 4 <sup>19</sup> / <sub>32</sub> x 7 <sup>29</sup> / <sub>32</sub>      |
| 3450/3440red | ((W÷2) - 9.4) x 146.0 | ((W÷2) - <sup>3</sup> / <sub>8</sub> ) x 5 <sup>3</sup> / <sub>4</sub> |

Note: Not available with exterior profiles D, F, H, P, V and W.  
red = reduced rails / W = width

Default exterior profile: Q

Series 40 and 50 drawer fronts are manufactured with regular rails.  
If reduced rails drawer fronts are required, it must be specify when ordering.

Model **2140**  
Color: A661S



40

Category 2

# STANDARD MODELS

## OPTIONS:

- See availability of same color melamine back, pages 47-48.
- For regular rails drawer fronts, order as a door.

## SERIES 73 Category 3



Model **2173**  
Color: K464WT

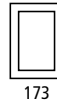
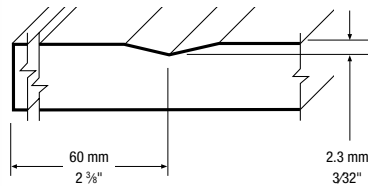

Model **3173**  
Reduced rails

### Minimum dimensions

#### Doors (Height x Width)

| Model | mm                                 | inches   |
|-------|------------------------------------|--|
| 2173  | 153.7 x 153.7                      | 6 1/16 x 6 1/16                                      |
| 2273  | 168.7 x 153.7                      | 6 21/32 x 6 1/16                                     |
| 2373  | 193.7 x 200.0                      | 7 21/32 x 7 7/8                                      |
| 2473  | $((W \div 2) + 60.1) \times 153.7$ | $((W \div 2) + 2 \frac{3}{8}) \times 6 \frac{1}{16}$ |

#### Drawer fronts (Height x Width)

| Model | mm                                | inches                                      |
|-------|-----------------------------------|---|
| 3173  | 93.7 x 153.7                      | 3 23/32 x 6 1/16                            |
| 3273  | 108.7 x 153.7                     | 4 9/32 x 6 1/16                             |
| 3373  | 133.7 x 200.0                     | 5 9/32 x 7 7/8                              |
| 3473  | $((W \div 2) + 0.1) \times 153.7$ | $((W \div 2) + 1/32) \times 6 \frac{1}{16}$ |

W = width  
Default exterior profile: B

## SERIES 76 Category 4



Model **2176**  
Color: K257S

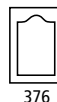
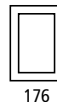
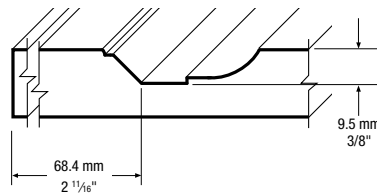

Model **3176**  
Reduced rails

### Minimum dimensions

#### Doors (Height x Width)

| Model | mm                                 | inches  |
|-------|------------------------------------|---|
| 2176  | 216.1 x 216.1                      | 8 17/32 x 8 17/32                                       |
| 2276  | 231.1 x 216.1                      | 9 1/8 x 8 17/32   |
| 2376  | 256.1 x 216.1                      | 10 3/32 x 8 17/32                                       |
| 2476  | $((W \div 2) + 87.7) \times 216.1$ | $((W \div 2) + 3 \frac{15}{32}) \times 8 \frac{17}{32}$ |

#### Drawer fronts (Height x Width)

| Model | mm                                 | inches  |
|-------|------------------------------------|---|
| 3176  | 149.2 x 216.1                      | 5 7/8 x 8 17/32                               |
| 3276  | 164.2 x 216.1                      | 6 15/32 x 8 17/32                             |
| 3376  | 189.2 x 216.1                      | 7 15/32 x 8 17/32                             |
| 3476  | $((W \div 2) + 20.9) \times 216.1$ | $((W \div 2) + 27/32) \times 8 \frac{17}{32}$ |

W = width  
Default exterior profile: B



## STANDARD SPECIFICATIONS

- White melamine back
- The default woodgrain direction is vertical
- Drawer fronts are manufactured with reduced rails (unless regular rails are specified)
- Maximum door height: 2438 mm (96"), maximum door width: 1193 mm (47")

### SERIES 83 Cat. 6 / 93 Cat. 5



Model **2183**  
Color: K257S

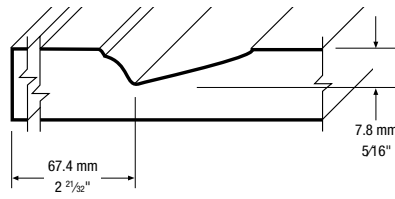

- 83 | Square and beveled corners
- 93 | Square interior profile as series 83, without beveled corners



183

193



283

293



383

393



483

493



Model **3183**  
Reduced rails



Model **2193**  
Color: K257S

93

Category 5

#### Minimum dimensions

##### Doors (Height x Width)

| Model     | mm                                  | inches                                 |
|-----------|-------------------------------------|--|
| 2183/2193 | 201.5 x 201.5                       | 7 15/16 x 7 15/16                      |
| 2283/2293 | 216.5 x 201.5                       | 8 17/32 x 7 15/16                      |
| 2383/2393 | 241.5 x 230.8                       | 9 17/32 x 9 3/32                       |
| 2483/2493 | $((W \div 2) + 112.5) \times 201.5$ | $((W \div 2) + 4 7/16) \times 7 15/16$ |

##### Drawer fronts (Height x Width)

| Model     | mm                                 | inches                                  |
|-----------|------------------------------------|---|
| 3183/3193 | 138.3 x 201.5                      | 5 15/32 x 7 15/16                       |
| 3283/3293 | 153.3 x 201.5                      | 6 1/16 x 7 15/16                        |
| 3383/3393 | 178.3 x 230.8                      | 7 1/32 x 9 3/32                         |
| 3483/3493 | $((W \div 2) + 49.3) \times 201.5$ | $((W \div 2) + 1 31/32) \times 7 15/16$ |

W = width

Default exterior profile: C

### SERIES 85 Cat. 6 / 95 Cat. 5



Model **2185**  
Color: K464WT

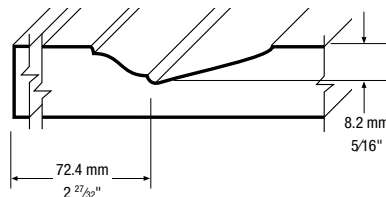

- 85 | Square and beveled corners
- 95 | Square interior profile as series 85, without beveled corners



185

195



285

295



385

395



485

495



Model **3185**  
Reduced rails



Model **2195**  
Color: K464WT

95

Category 5

#### Minimum dimensions

##### Doors (Height x Width)

| Model     | mm                                  | inches                                |
|-----------|-------------------------------------|---------------------------------------|
| 2185/2195 | 212.4 x 212.4                       | 8 3/8 x 8 3/8                         |
| 2285/2295 | 227.4 x 212.4                       | 8 31/32 x 8 3/8                       |
| 2385/2395 | 252.4 x 250.8                       | 9 15/16 x 9 7/8                       |
| 2485/2495 | $((W \div 2) + 117.5) \times 212.4$ | $((W \div 2) + 4 21/32) \times 8 3/8$ |

##### Drawer fronts (Height x Width)

| Model     | mm                                 | inches                               |
|-----------|------------------------------------|--------------------------------------|
| 3185/3195 | 149.2 x 212.4                      | 5 7/8 x 8 3/8                        |
| 3285/3295 | 164.2 x 212.4                      | 6 15/32 x 8 3/8                      |
| 3385/3395 | 189.2 x 250.8                      | 7 15/32 x 9 7/8                      |
| 3485/3495 | $((W \div 2) + 54.3) \times 212.4$ | $((W \div 2) + 2 5/32) \times 8 3/8$ |

W = width

Default exterior profile: C

# STANDARD MODELS

## OPTIONS:

- See availability of same color melamine back, pages 47-48.
- For regular rails drawer fronts, order as a door.

## SERIES 86 Cat. 6 / 96 Cat. 5



Model **2186**  
Color: R82S

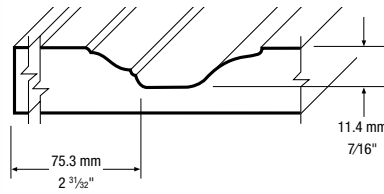

- 86 | Square and beveled corners
- 96 | Square interior profile as series 86, without beveled corners



186  
196



286  
296



386  
396



486  
496



Model **3186**  
Reduced rails



Model **2196**  
Color: R82S

96

Category 5

### Minimum dimensions

Doors (Height x Width)

| Model     | mm                                  | inches                                |
|-----------|-------------------------------------|---------------------------------------|
| 2186/2196 | 237.4 x 237.4                       | 9 3/8 x 9 3/8                         |
| 2286/2296 | 252.4 x 237.4                       | 9 15/16 x 9 3/8                       |
| 2386/2396 | 277.4 x 250.8                       | 10 15/16 x 9 7/8                      |
| 2486/2496 | $((W \div 2) + 117.5) \times 237.4$ | $((W \div 2) + 4 21/32) \times 9 3/8$ |

Drawer fronts (Height x Width)

| Model     | mm                                 | inches                               |
|-----------|------------------------------------|--------------------------------------|
| 3186/3196 | 174.2 x 237.4                      | 6 7/8 x 9 3/8                        |
| 3286/3296 | 189.2 x 237.4                      | 7 15/32 x 9 3/8                      |
| 3386/3396 | 214.2 x 250.8                      | 8 7/16 x 9 7/8                       |
| 3486/3496 | $((W \div 2) + 54.3) \times 237.4$ | $((W \div 2) + 2 5/32) \times 9 3/8$ |

W = width

Default exterior profile: C

## SERIES 87 Cat. 6 / 97 Cat. 5



Model **2187**  
Color: A15WT

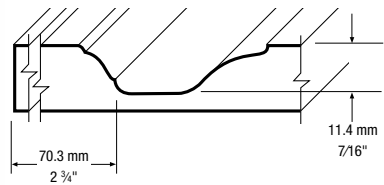

- 87 | Square and beveled corners
- 97 | Square interior profile as series 87, without beveled corners



187  
197



287  
297



387  
397



487  
497



Model **3187**  
Reduced rails



Model **2197**  
Color: A15WT

97

Category 5

### Minimum dimensions

Doors (Height x Width)

| Model     | mm                                  | inches                                 |
|-----------|-------------------------------------|--|
| 2187/2197 | 227.4 x 227.4                       | 8 31/32 x 8 31/32                      |
| 2287/2297 | 242.4 x 227.4                       | 9 9/16 x 8 31/32                       |
| 2387/2397 | 267.4 x 230.8                       | 10 17/32 x 9 3/32                      |
| 2487/2497 | $((W \div 2) + 112.5) \times 227.4$ | $((W \div 2) + 4 7/16) \times 8 31/32$ |

Drawer fronts (Height x Width)

| Model     | mm                                 | inches                                  |
|-----------|------------------------------------|---|
| 3187/3197 | 164.2 x 227.4                      | 6 15/32 x 8 31/32                       |
| 3287/3297 | 179.2 x 227.4                      | 7 1/16 x 8 31/32                        |
| 3387/3397 | 204.2 x 230.8                      | 8 1/16 x 9 3/32                         |
| 3487/3497 | $((W \div 2) + 49.3) \times 227.4$ | $((W \div 2) + 1 31/32) \times 8 31/32$ |

W = width

Default exterior profile: C

## STANDARD SPECIFICATIONS

- White melamine back
- The default woodgrain direction is vertical
- Drawer fronts are manufactured with reduced rails (unless regular rails are specified)
- Maximum door height: 2438 mm (96"), maximum door width: 1193 mm (47")

## SERIES 88 Cat. 6 / 98 Cat. 5



Model **2188**  
Color: A15WT

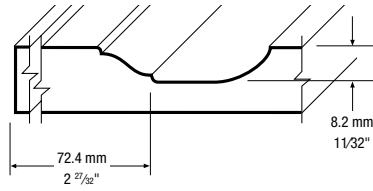

- 88 | Square and beveled corners
- 98 | Square interior profile as series 88, without beveled corners



188



198



288



298



388



398



488



498



Model **3188**  
Reduced rails

### Minimum dimensions

#### Doors (Height x Width)

| Model     | mm                                  | inches                                  |
|-----------|-------------------------------------|---|
| 2188/2198 | 214.9 x 214.9                       | 8 15/32 x 8 15/32                       |
| 2288/2298 | 229.9 x 214.9                       | 9 1/16 x 8 15/32                        |
| 2388/2398 | 254.9 x 250.8                       | 10 1/16 x 9 7/8                         |
| 2488/2498 | $((W \div 2) + 117.5) \times 214.9$ | $((W \div 2) + 4 21/32) \times 8 15/32$ |

#### Drawer fronts (Height x Width)

| Model     | mm                                 | inches                                 |
|-----------|------------------------------------|--|
| 3188/3198 | 151.7 x 214.9                      | 6 x 8 15/32                            |
| 3288/3298 | 166.7 x 214.9                      | 6 9/16 x 8 15/32                       |
| 3388/3398 | 191.7 x 250.8                      | 7 9/16 x 9 7/8                         |
| 3488/3498 | $((W \div 2) + 54.3) \times 214.9$ | $((W \div 2) + 2 5/32) \times 8 15/32$ |

W = width

Default exterior profile: C



Model **2198**  
Color: A15WT

98

Category 5

## SERIES 89 Cat. 6 / 99 Cat. 5



Model **2189**  
Color: R82S

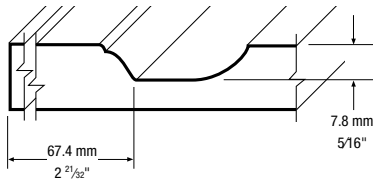

- 89 | Square and beveled corners
- 99 | Square interior profile as series 89, without beveled corners



189



199



289



299



389



399



489



499



Model **3189**  
Reduced rails

### Minimum dimensions

#### Doors (Height x Width)

| Model     | mm                                  | inches                                |
|-----------|-------------------------------------|---------------------------------------|
| 2189/2199 | 204.4 x 204.4                       | 8 1/16 x 8 1/16                       |
| 2289/2299 | 219.4 x 204.4                       | 8 21/32 x 8 1/16                      |
| 2389/2399 | 244.4 x 230.8                       | 9 5/8 x 9 3/16                        |
| 2489/2499 | $((W \div 2) + 112.5) \times 204.4$ | $((W \div 2) + 4 7/16) \times 8 1/16$ |

#### Drawer fronts (Height x Width)

| Model     | mm                                 | inches                                 |
|-----------|------------------------------------|--|
| 3189/3199 | 141.2 x 204.4                      | 5 9/16 x 8 1/16                        |
| 3289/3299 | 156.2 x 204.4                      | 6 5/32 x 8 1/16                        |
| 3389/3399 | 181.2 x 230.8                      | 7 5/32 x 9 3/16                        |
| 3489/3499 | $((W \div 2) + 49.3) \times 204.4$ | $((W \div 2) + 1 31/32) \times 8 1/16$ |

W = width

Default exterior profile: C



Model **2199**  
Color: R82S

99

Category 5

# STANDARD MODELS

## OPTIONS:

- See availability of same color melamine back, pages 47-48.
- For regular rails drawer fronts, order as a door.

## SERIES 912 Category 3



Model **2912**  
Color: K85S

R = 3 mm

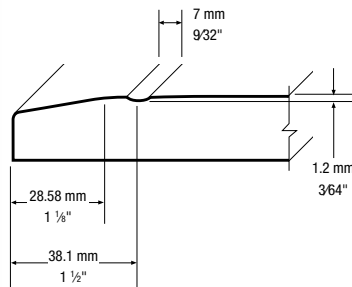

R = 3 mm

Model **3912**  
Regular rails

### Minimum dimensions

Doors (Height x Width)

| Model | mm          | inches  |
|-------|-------------|---|
| 2912  | 95.9 x 95.9 | 3 <sup>25</sup> / <sub>32</sub> x 3 <sup>25</sup> / <sub>32</sub> |

Drawer fronts (Height x Width)

| Model | mm          | inches  |
|-------|-------------|---|
| 3912  | 95.9 x 95.9 | 3 <sup>25</sup> / <sub>32</sub> x 3 <sup>25</sup> / <sub>32</sub> |

Default exterior profile: F

Model 912 drawer fronts are manufactured with regular rails.

## SERIES 01 Category 2



Model **2101**  
Color: V66WT

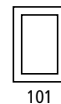
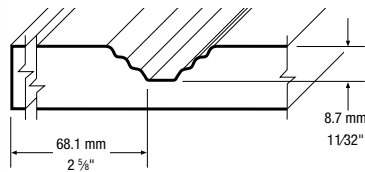

Model **3101**  
Reduced rails

### Minimum dimensions

Doors (Height x Width)

| Model | mm                     | inches  |
|-------|------------------------|---|
| 2101  | 182.8 x 182.8          | 7 <sup>7</sup> / <sub>32</sub> x 7 <sup>7</sup> / <sub>32</sub>             |
| 2201  | 201.3 x 182.8          | 7 <sup>15</sup> / <sub>16</sub> x 7 <sup>7</sup> / <sub>32</sub>            |
| 2301  | 222.8 x 182.8          | 8 <sup>25</sup> / <sub>32</sub> x 7 <sup>7</sup> / <sub>32</sub>            |
| 2401  | ((W÷2) + 71.6) x 182.8 | ((W÷2) + 2 <sup>27</sup> / <sub>32</sub> ) x 7 <sup>7</sup> / <sub>32</sub> |

Drawer fronts (Height x Width)

| Model | mm                    | inches  |
|-------|-----------------------|---|
| 3101  | 120.2 x 182.8         | 4 <sup>3</sup> / <sub>4</sub> x 7 <sup>7</sup> / <sub>32</sub>          |
| 3201  | 138.7 x 182.8         | 5 <sup>15</sup> / <sub>32</sub> x 7 <sup>7</sup> / <sub>32</sub>        |
| 3301  | 160.2 x 182.8         | 6 <sup>5</sup> / <sub>16</sub> x 7 <sup>7</sup> / <sub>32</sub>         |
| 3401  | ((W÷2) + 9.0) x 182.8 | ((W÷2) + <sup>3</sup> / <sub>8</sub> ) x 7 <sup>7</sup> / <sub>32</sub> |

W = width

Default exterior profile: C

## STANDARD SPECIFICATIONS

- White melamine back
- The default woodgrain direction is vertical

- Drawer fronts are manufactured with reduced rails (unless regular rails are specified)
- Maximum door height: 2438 mm (96"), maximum door width: 1193 mm (47")

## SERIES 04 Category 2



Model **2104**  
Color: V66WT

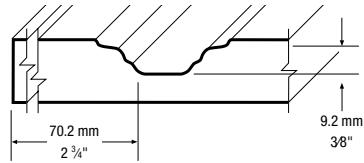

104



204



304



404



Model **3104**  
Reduced rails

### Minimum dimensions

Doors (Height x Width)

| Model | mm                     | inches   |
|-------|------------------------|--|
| 2104  | 199.0 x 199.0          | 7 <sup>27</sup> / <sub>32</sub> x 7 <sup>27</sup> / <sub>32</sub>            |
| 2204  | 214.0 x 199.0          | 8 <sup>7</sup> / <sub>16</sub> x 7 <sup>27</sup> / <sub>32</sub>             |
| 2304  | 239.0 x 199.0          | 9 <sup>7</sup> / <sub>16</sub> x 7 <sup>27</sup> / <sub>32</sub>             |
| 2404  | ((W÷2) + 75.1) x 199.0 | ((W÷2) + 2 <sup>31</sup> / <sub>32</sub> ) x 7 <sup>27</sup> / <sub>32</sub> |

Drawer fronts (Height x Width)

| Model | mm                     | inches  |
|-------|------------------------|---|
| 3104  | 136.4 x 199.0          | 5 <sup>3</sup> / <sub>8</sub> x 7 <sup>27</sup> / <sub>32</sub>   |
| 3204  | 151.4 x 199.0          | 5 <sup>31</sup> / <sub>32</sub> x 7 <sup>27</sup> / <sub>32</sub> |
| 3304  | 179.4 x 199.0          | 7 <sup>3</sup> / <sub>32</sub> x 7 <sup>27</sup> / <sub>32</sub>  |
| 3404  | ((W÷2) + 12.5) x 199.0 | ((W÷2) + 1/2) x 7 <sup>27</sup> / <sub>32</sub>                   |

W = width

Default exterior profile: C

## SERIES 06 Category 3



Model **2106**  
Color: K85S

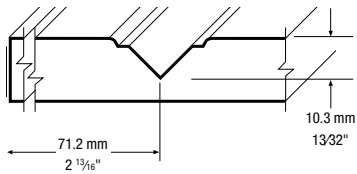

106



206



306



406



Model **3106**  
Reduced rails

### Minimum dimensions

Doors (Height x Width)

| Model | mm                     | inches  |
|-------|------------------------|---|
| 2106  | 180.2 x 180.2          | 7 <sup>1</sup> / <sub>8</sub> x 7 <sup>1</sup> / <sub>8</sub>             |
| 2206  | 195.2 x 180.2          | 7 <sup>11</sup> / <sub>16</sub> x 7 <sup>1</sup> / <sub>8</sub>           |
| 2306  | 220.2 x 180.2          | 8 <sup>11</sup> / <sub>16</sub> x 7 <sup>1</sup> / <sub>8</sub>           |
| 2406  | ((W÷2) + 81.5) x 180.2 | ((W÷2) + 3 <sup>7</sup> / <sub>32</sub> ) x 7 <sup>1</sup> / <sub>8</sub> |

Drawer fronts (Height x Width)

| Model | mm                    | inches   |
|-------|-----------------------|--|
| 3106  | 101.6 x 180.2         | 4 x 7 <sup>3</sup> / <sub>32</sub>                               |
| 3206  | 116.6 x 180.2         | 4 <sup>19</sup> / <sub>32</sub> x 7 <sup>3</sup> / <sub>32</sub> |
| 3306  | 141.6 x 180.2         | 5 <sup>19</sup> / <sub>32</sub> x 7 <sup>3</sup> / <sub>32</sub> |
| 3406  | ((W÷2) + 2.9) x 180.2 | ((W÷2) + 1/8) x 7 <sup>3</sup> / <sub>32</sub>                   |

W = width

Default exterior profile: B

# STANDARD MODELS

## OPTIONS:

- See availability of same color melamine back, pages 47-48.
- For regular rails drawer fronts, order as a door.

## SERIES 07 Category 5



Model **2107**  
Color: A661S

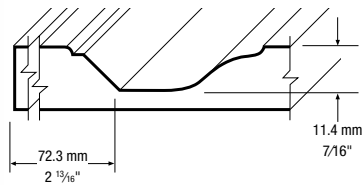

107



207



307



407



Model **3107**  
Reduced rails

### Minimum dimensions

#### Doors (Height x Width)

| Model | mm                     | inches   |
|-------|------------------------|--|
| 2107  | 235.0 x 235.0          | 9 <sup>9</sup> / <sub>32</sub> x 9 <sup>9</sup> / <sub>32</sub>            |
| 2207  | 250.0 x 235.0          | 9 <sup>27</sup> / <sub>32</sub> x 9 <sup>9</sup> / <sub>32</sub>           |
| 2307  | 275.0 x 235.0          | 10 <sup>27</sup> / <sub>32</sub> x 9 <sup>9</sup> / <sub>32</sub>          |
| 2407  | ((W÷2) + 86.8) x 235.0 | ((W÷2) + 3 <sup>7</sup> / <sub>16</sub> ) x 9 <sup>9</sup> / <sub>32</sub> |

#### Drawer fronts (Height x Width)

| Model | mm                    | inches  |
|-------|-----------------------|---|
| 3107  | 156.4 x 235.0         | 6 <sup>3</sup> / <sub>16</sub> x 9 <sup>9</sup> / <sub>32</sub>           |
| 3207  | 171.4 x 235.0         | 6 <sup>3</sup> / <sub>4</sub> x 9 <sup>9</sup> / <sub>32</sub>            |
| 3307  | 196.4 x 235.0         | 7 <sup>3</sup> / <sub>4</sub> x 9 <sup>9</sup> / <sub>32</sub>            |
| 3407  | ((W÷2) + 8.2) x 235.0 | ((W÷2) + <sup>11</sup> / <sub>32</sub> ) x 9 <sup>9</sup> / <sub>32</sub> |

W = width  
Default exterior profile: B

## SERIES 08 Category 3



Model **2108**  
Color: A4WT

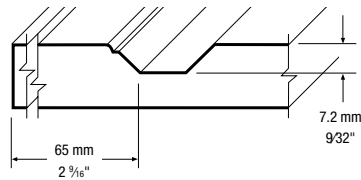

108



208



308



408



Model **3108**  
Reduced rails

### Minimum dimensions

#### Doors (Height x Width)

| Model | mm                     | inches  |
|-------|------------------------|---|
| 2108  | 185.1 x 185.1          | 7 <sup>5</sup> / <sub>16</sub> x 7 <sup>5</sup> / <sub>16</sub>             |
| 2208  | 200.1 x 185.1          | 7 <sup>29</sup> / <sub>32</sub> x 7 <sup>5</sup> / <sub>16</sub>            |
| 2308  | 225.1 x 185.1          | 8 <sup>7</sup> / <sub>8</sub> x 7 <sup>5</sup> / <sub>16</sub>              |
| 2408  | ((W÷2) + 71.8) x 185.1 | ((W÷2) + 2 <sup>27</sup> / <sub>32</sub> ) x 7 <sup>5</sup> / <sub>16</sub> |

#### Drawer fronts (Height x Width)

| Model | mm                    | inches   |
|-------|-----------------------|--|
| 3108  | 120.5 x 185.1         | 4 <sup>3</sup> / <sub>4</sub> x 7 <sup>5</sup> / <sub>16</sub>           |
| 3208  | 135.5 x 185.1         | 5 <sup>11</sup> / <sub>32</sub> x 7 <sup>5</sup> / <sub>16</sub>         |
| 3308  | 160.5 x 185.1         | 6 <sup>11</sup> / <sub>32</sub> x 7 <sup>5</sup> / <sub>16</sub>         |
| 3408  | ((W÷2) + 7.8) x 185.1 | ((W÷2) + <sup>5</sup> / <sub>16</sub> ) x 7 <sup>5</sup> / <sub>16</sub> |

W = width  
Default exterior profile: B



## STANDARD SPECIFICATIONS

- White melamine back
- The default woodgrain direction is vertical

- Drawer fronts are manufactured with reduced rails (unless regular rails are specified)
- Maximum door height: 2438 mm (96"), maximum door width: 1193 mm (47")

## SERIES 09 Category 3



Model **2109**  
Color: A4WT

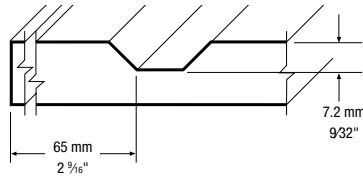

Model **3109**  
Reduced rails

### Minimum dimensions

#### Doors (Height x Width)

| Model | mm                                 | inches                                 |
|-------|------------------------------------|--|
| 2109  | 185.1 x 185.1                      | 7 5/16 x 7 5/16                        |
| 2209  | 200.1 x 185.1                      | 7 29/32 x 7 5/16                       |
| 2309  | 225.1 x 185.1                      | 8 7/8 x 7 5/16                         |
| 2409  | $((W \div 2) + 71.8) \times 185.1$ | $((W \div 2) + 2 27/32) \times 7 5/16$ |

#### Drawer fronts (Height x Width)

| Model | mm                                | inches                              |
|-------|-----------------------------------|-------------------------------------|
| 3109  | 121.1 x 185.1                     | 4 25/32 x 7 5/16                    |
| 3209  | 136.1 x 185.1                     | 5 3/8 x 7 5/16                      |
| 3309  | 161.1 x 185.1                     | 6 11/32 x 7 5/16                    |
| 3409  | $((W \div 2) + 7.8) \times 185.1$ | $((W \div 2) + 5/16) \times 7 5/16$ |

W = width

Default exterior profile: B

## SERIES 15 Category 2



Model **2115**  
Color: A661S

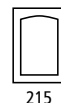
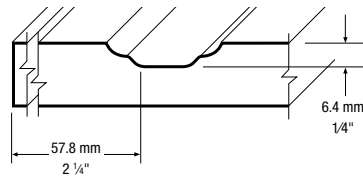

Model **3115**  
Reduced rails

### Minimum dimensions

#### Doors (Height x Width)

| Model | mm                                 | inches                                |
|-------|------------------------------------|---------------------------------------|
| 2115  | 170.5 x 170.5                      | 6 23/32 x 6 23/32                     |
| 2215  | 185.8 x 170.5                      | 7 11/32 x 6 23/32                     |
| 2315  | 210.5 x 170.5                      | 8 5/16 x 6 23/32                      |
| 2415  | $((W \div 2) + 63.1) \times 170.5$ | $((W \div 2) + 2 1/2) \times 6 23/32$ |

#### Drawer fronts (Height x Width)

| Model | mm                                 | inches                                |
|-------|------------------------------------|---------------------------------------|
| 3115  | 127.1 x 170.5                      | 5 1/32 x 6 23/32                      |
| 3215  | 142.1 x 170.5                      | 5 5/8 x 6 23/32                       |
| 3315  | 167.1 x 170.5                      | 6 19/32 x 6 23/32                     |
| 3415  | $((W \div 2) + 19.7) \times 170.5$ | $((W \div 2) + 25/32) \times 6 23/32$ |

W = width

Default exterior profile: U

# STANDARD MODELS

## OPTIONS:

- See availability of same color melamine back, pages 47-48.
- For regular rails drawer fronts, order as a door.

## SERIES 31 Category 3



Model **2131**  
Color: K464WT

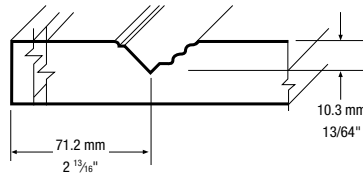

Model **3131**  
Reduced rails

### Minimum dimensions

Doors (Height x Width)

| Model | mm            | inches            |
|-------|---------------|-------------------|
| 2131  | 199.4 x 199.4 | 7 27/32 x 7 27/32 |

Drawer fronts (Height x Width)

| Model | mm            | inches          |
|-------|---------------|-----------------|
| 3131  | 120.8 x 199.4 | 4 3/4 x 7 27/32 |

Default exterior profile: O

## SERIES 32 Category 2



Model **2132**  
Color: K257S

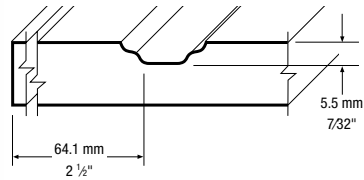

132



232



332



432



Model **3132**  
Reduced rails

### Minimum dimensions

Doors (Height x Width)

| Model | mm                                 | inches                                  |
|-------|------------------------------------|---|
| 2132  | 173.7 x 173.7                      | 6 27/32 x 6 27/32                       |
| 2232  | 188.7 x 173.7                      | 7 7/16 x 6 27/32                        |
| 2332  | 213.7 x 173.7                      | 8 7/16 x 6 27/32                        |
| 2432  | $((W \div 2) + 68.8) \times 173.7$ | $((W \div 2) + 2 23/32) \times 6 27/32$ |

Drawer fronts (Height x Width)

| Model | mm                                | inches                               |
|-------|-----------------------------------|--------------------------------------|
| 3132  | 110.1 x 173.7                     | 4 11/32 x 6 27/32                    |
| 3232  | 125.1 x 173.7                     | 4 15/16 x 6 27/32                    |
| 3332  | 150.1 x 173.7                     | 5 15/16 x 6 27/32                    |
| 3432  | $((W \div 2) + 5.2) \times 173.7$ | $((W \div 2) + 7/32) \times 6 27/32$ |

W = width

Default exterior profile: C

## STANDARD SPECIFICATIONS

- White melamine back
- The default woodgrain direction is vertical

- Drawer fronts are manufactured with reduced rails (unless regular rails are specified)
- Maximum door height: 2438 mm (96"), maximum door width: 1193 mm (47")

## SERIES 33 Category 3



Model **2133**  
Color: K257S

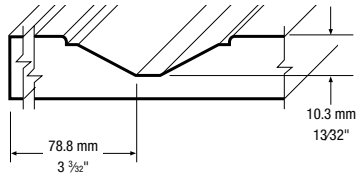

Model **3133**  
Reduced rails

### Minimum dimensions

#### Doors (Height x Width)

| Model | mm                                 | inches                              |
|-------|------------------------------------|-------------------------------------|
| 2133  | 225.0 x 225.0                      | 8 7/8 x 8 7/8                       |
| 2233  | 240.0 x 225.0                      | 9 15/32 x 8 7/8                     |
| 2333  | 265.0 x 225.0                      | 10 7/16 x 8 7/8                     |
| 2433  | $((W \div 2) + 82.5) \times 225.0$ | $((W \div 2) + 3 1/4) \times 8 7/8$ |

#### Drawer fronts (Height x Width)

| Model | mm                                | inches                             |
|-------|-----------------------------------|------------------------------------|
| 3133  | 146.4 x 225.0                     | 5 25/32 x 8 7/8                    |
| 3233  | 161.4 x 225.0                     | 6 3/8 x 8 7/8                      |
| 3333  | 186.4 x 225.0                     | 7 11/32 x 8 7/8                    |
| 3433  | $((W \div 2) + 3.9) \times 225.0$ | $((W \div 2) + 5/32) \times 8 7/8$ |

W = width  
Default exterior profile: A

## SERIES 39 Category 3



Model **2139**  
Color: K464WT

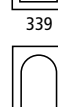
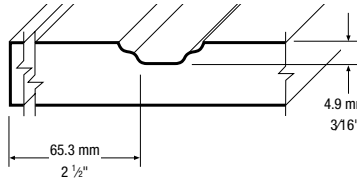

Model **3139**  
Reduced rails

### Minimum dimensions

#### Doors (Height x Width)

| Model | mm                                 | inches                                  |
|-------|------------------------------------|---|
| 2139  | 175.7 x 175.7                      | 6 15/16 x 6 15/16                       |
| 2239  | 190.7 x 175.7                      | 7 17/32 x 6 15/16                       |
| 2339  | 215.7 x 200.6                      | 8 1/2 x 7 29/32                         |
| 2439  | $((W \div 2) + 70.0) \times 175.7$ | $((W \div 2) + 2 25/32) \times 6 15/16$ |

#### Drawer fronts (Height x Width)

| Model | mm                                | inches                               |
|-------|-----------------------------------|--------------------------------------|
| 3139  | 112.1 x 175.7                     | 4 7/16 x 6 15/16                     |
| 3239  | 127.1 x 175.7                     | 5 1/32 x 6 15/16                     |
| 3339  | 152.1 x 200.6                     | 6 x 7 29/32                          |
| 3439  | $((W \div 2) + 6.4) \times 175.7$ | $((W \div 2) + 9/32) \times 6 15/16$ |

W = width  
Default exterior profile: C

# STANDARD MODELS

## OPTIONS:

- See availability of same color melamine back, pages 47-48.
- For regular rails drawer fronts, order as a door.

## SERIES 46 Category 3



Model **2146**  
Color: R82S

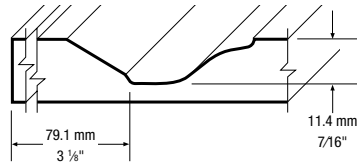

146



246



346



446



Model **3146**  
Reduced rails

### Minimum dimensions

#### Doors (Height x Width)

| Model | mm                                 | inches                                |
|-------|------------------------------------|---------------------------------------|
| 2146  | 234.4 x 234.4                      | 9 1/4 x 9 1/4                         |
| 2246  | 254.4 x 234.4                      | 10 1/32 x 9 1/4                       |
| 2346  | 284.4 x 234.4                      | 11 7/32 x 9 1/4                       |
| 2446  | $((W \div 2) + 86.5) \times 234.4$ | $((W \div 2) + 3 13/32) \times 9 1/4$ |

#### Drawer fronts (Height x Width)

| Model | mm                                 | inches                              |
|-------|------------------------------------|-------------------------------------|
| 3146  | 165.8 x 234.4                      | 6 17/32 x 9 1/4                     |
| 3246  | 185.8 x 234.4                      | 7 11/32 x 9 1/4                     |
| 3346  | 215.8 x 234.4                      | 8 1/2 x 9 1/4                       |
| 3446  | $((W \div 2) + 17.9) \times 234.4$ | $((W \div 2) + 23/32) \times 9 1/4$ |

W = width  
Default exterior profile: C

## SERIES 47 Category 2



Model **2147**  
Color: A15WT

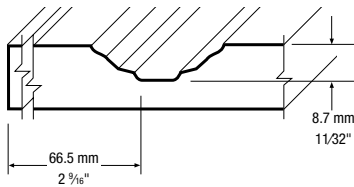

147



247



347



447



Model **3147**  
Reduced rails

### Minimum dimensions

#### Doors (Height x Width)

| Model | mm                                 | inches                               |
|-------|------------------------------------|--------------------------------------|
| 2147  | 185.5 x 185.5                      | 7 5/16 x 7 5/16                      |
| 2247  | 200.5 x 185.5                      | 7 29/32 x 7 5/16                     |
| 2347  | 228.5 x 210.0                      | 9 x 8 9/32                           |
| 2447  | $((W \div 2) + 69.8) \times 185.5$ | $((W \div 2) + 2 3/4) \times 7 5/16$ |

#### Drawer fronts (Height x Width)

| Model | mm                                 | inches                              |
|-------|------------------------------------|-------------------------------------|
| 3147  | 129.5 x 185.5                      | 5 1/8 x 7 5/16                      |
| 3247  | 144.5 x 185.5                      | 5 23/32 x 7 5/16                    |
| 3347  | 172.5 x 210.0                      | 6 13/16 x 8 9/32                    |
| 3447  | $((W \div 2) + 13.8) \times 185.5$ | $((W \div 2) + 9/16) \times 7 5/16$ |

W = width  
Default exterior profile: C

## STANDARD SPECIFICATIONS

- White melamine back
- The default woodgrain direction is vertical
- Drawer fronts are manufactured with reduced rails (unless regular rails are specified)
- Maximum door height: 2438 mm (96"), maximum door width: 1193 mm (47")

## SERIES 48 Category 3



Model **2148**  
Color: A15WT

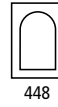
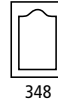
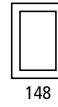
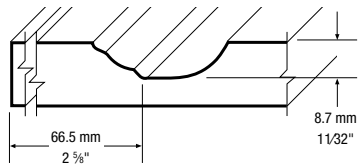

Model **3148**  
Reduced rails

### Minimum dimensions

#### Doors (Height x Width)

| Model | mm                                 | inches                                  |
|-------|------------------------------------|---|
| 2148  | 187.8 x 187.8                      | 7 13/16 x 7 13/32                       |
| 2248  | 202.8 x 187.8                      | 8 x 7 13/32                             |
| 2348  | 230.8 x 210.0                      | 9 3/32 x 8 9/32                         |
| 2448  | $((W \div 2) + 73.1) \times 187.8$ | $((W \div 2) + 2 29/32) \times 7 13/32$ |

#### Drawer fronts (Height x Width)

| Model | mm                                 | inches                                 |
|-------|------------------------------------|--|
| 3148  | 131.8 x 187.8                      | 5 7/32 x 7 13/32                       |
| 3248  | 146.8 x 187.8                      | 5 25/32 x 7 13/32                      |
| 3348  | 174.8 x 210.0                      | 6 29/32 x 8 9/32                       |
| 3448  | $((W \div 2) + 17.1) \times 187.8$ | $((W \div 2) + 1 1/16) \times 7 13/32$ |

W = width

Default exterior profile: C



# SPECIAL MODELS

## OPTION:

- See availability of same color melamine back, pages 47-48.

## SERIES 911 Category 3



Model **2911**  
Color: K85S

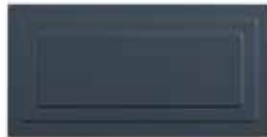
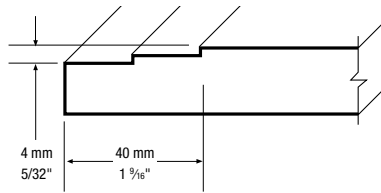

Model **3911**

### Minimum dimensions

Doors and drawer fronts (Height x Width)

| Model     | mm          | inches            |
|-----------|-------------|-------------------|
| 2911/3911 | 92.7 x 92.7 | 3 21/32 x 3 21/32 |

Default exterior profile: series 911 is manufactured with its own exterior profile.

## SERIES 921 / 922 / 923 / 924 Cat. 3



Model **2921**  
Color: V66WT

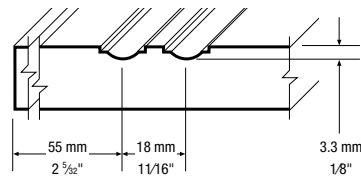

921

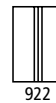

922



923

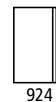

924



Model **3921**

### Minimum dimensions

Doors (Height x Width)

| Model | mm           | inches         |
|-------|--------------|----------------|
| 2921  | 38.1 x 128.0 | 1 1/2 x 5 1/16 |
| 2922  | 38.1 x 128.0 | 1 1/2 x 5 1/16 |
| 2923  | 38.1 x 171.4 | 1 1/2 x 6 3/4  |
| 2924  | 38.1 x 128.0 | 1 1/2 x 5 1/16 |

Drawer fronts (Height x Width)

| Model | mm           | inches         |
|-------|--------------|----------------|
| 3921  | 38.1 x 128.0 | 1 1/2 x 5 1/16 |
| 3922  | 38.1 x 128.0 | 1 1/2 x 5 1/16 |
| 3923  | 38.1 x 171.4 | 1 1/2 x 6 3/4  |
| 3924  | 38.1 x 128.0 | 1 1/2 x 5 1/16 |

Default exterior profile: series 921 to 924 are manufactured with their own exterior profile.



## STANDARD SPECIFICATIONS

- White melamine back
- The default woodgrain direction is vertical
- Drawer fronts are manufactured with reduced rails (unless regular rails are specified)
- Maximum door height: 2438 mm (96"), maximum door width: 1193 mm (47")

### SERIES 972 Category 3



Model **2972**  
Color: V66WT

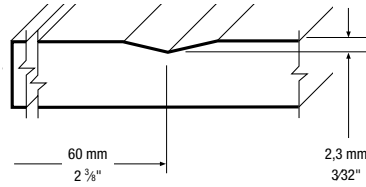

Model **3972**  
Reduced rails



Model **3975**  
Reduced rails

#### Minimum dimensions

##### Doors (Height x Width)

| Model | mm            | inches  |
|-------|---------------|---|
| 2972  | 264.2 x 213.7 | 10 <sup>13</sup> / <sub>32</sub> x 8 <sup>7</sup> / <sub>16</sub> |

##### Drawer fronts (Height x Width)

| Model | mm            | inches   |
|-------|---------------|--|
| 3972  | 144.2 x 213.7 | 5 <sup>11</sup> / <sub>16</sub> x 8 <sup>7</sup> / <sub>16</sub> |
| 3975  | 144.2 x 273.1 | 5 <sup>11</sup> / <sub>16</sub> x 10 <sup>3</sup> / <sub>4</sub> |

Default exterior profile: B

### SERIES 974 Category 4



Model **2974**  
Color: K85S

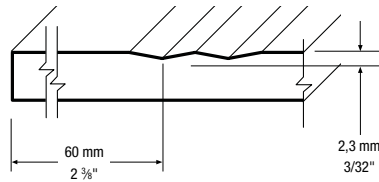

Model **3974**  
Reduced rails

#### Minimum dimensions

##### Doors (Height x Width)

| Model | mm            | inches  |
|-------|---------------|---|
| 2974  | 213.7 x 213.7 | 8 <sup>7</sup> / <sub>16</sub> x 8 <sup>7</sup> / <sub>16</sub> |

##### Drawer fronts (Height x Width)

| Model | mm            | inches   |
|-------|---------------|--|
| 3974  | 164.2 x 213.7 | 6 <sup>15</sup> / <sub>32</sub> x 8 <sup>7</sup> / <sub>16</sub> |

Default exterior profile: B

# SPECIAL MODELS

## STANDARD SPECIFICATIONS

- White melamine back
- The default woodgrain direction if vertical

- Drawer fronts are manufactured with reduced rails (unless regular rails are specified)
- Maximum door height: 2438 mm (96"), maximum door width: 1193 mm (47")

## SERIES 996 Category 3



Model **2996**  
Color: A661S



Model **3996**

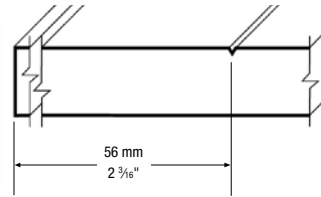

### FRAME DOOR

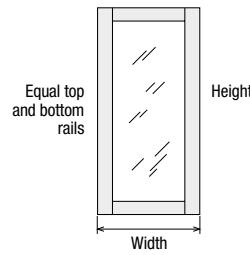

### Minimum dimensions

Doors and drawer fronts (Height x Width)

| Model     | mm           | inches         |
|-----------|--------------|----------------|
| 2996/3996 | 38.1 x 162.8 | 1 1/2 x 6 7/16 |

Note: Not available with exterior profiles D, F, H and P.  
Default exterior profile: Y

The first groove is 48 mm (1-57/64") from the top of the door. Door rails height vary according to door dimensions.

### ALIGNMENT OF ADJACENT DOORS AND DRAWERS

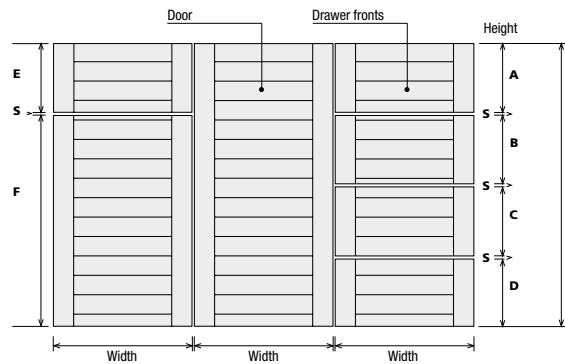

A, B, C, D, E, F and G: height of doors and drawers. / S: vertical space required between drawers.  
To align the grooves with other doors and drawers front, please specify it when ordering and provide us a drawing.

### VERTICAL CROSS SECTION

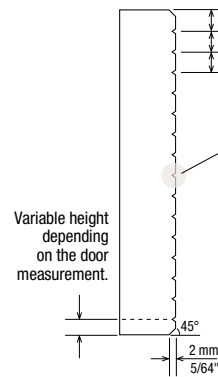

### HORIZONTAL CROSS SECTION

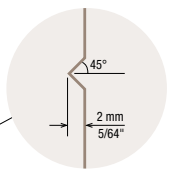

## SERIES 939 Category 3



Model **2939**  
Color: A4WT

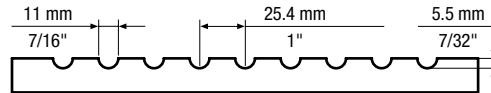

The first groove starts at the center of the door.

### Minimum dimensions

Doors (Height x Width)

| Model | mm          | inches |
|-------|-------------|--------|
| 2939  | 76.2 x 76.2 | 3 x 3  |

Default exterior profile: Q

The width of the stiles vary according to door dimensions.

# GROOVES ON CENTER PANELS



Color: K464WT



Single Vertical Grooves

If you require vertical grooves on your center panel, please choose this option when you place your order.

The vertical groove options on center panel are available on most door models. Please contact Customer Service for more information.

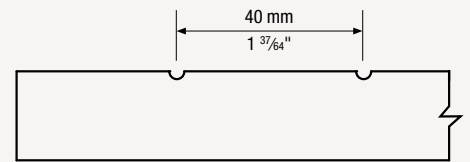

Color: K464WT



Double Vertical Grooves

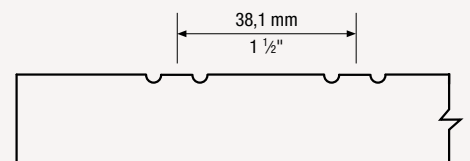



# PERSONALIZED SIGNATURE

FRAME AND  
MULLION DOORS

PANELS

MOULDINGS

ACCESSORIES

TECHNICAL  
SPECIFICATIONS

# FRAME AND MULLION DOORS



Model **4101**  
Color: V67WT

## Standards

### SERIES 4100

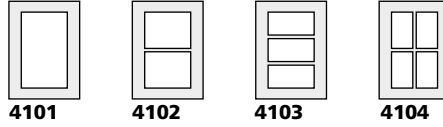

**4101**   **4102**   **4103**   **4104**

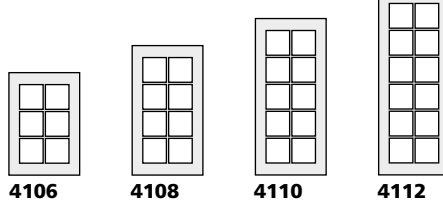

**4106**   **4108**   **4110**   **4112**

### SERIES 4200

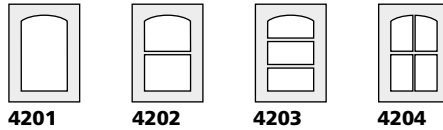

**4201**   **4202**   **4203**   **4204**

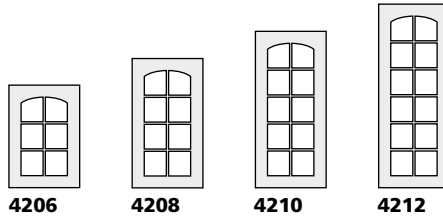

**4206**   **4208**   **4210**   **4212**

### SERIES 4300



**4301**   **4302**   **4303**   **4304**

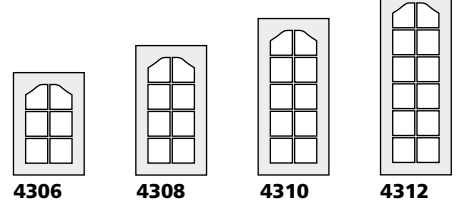

**4306**   **4308**   **4310**   **4312**

### SERIES 4400



**4401**   **4402**   **4403**   **4404**

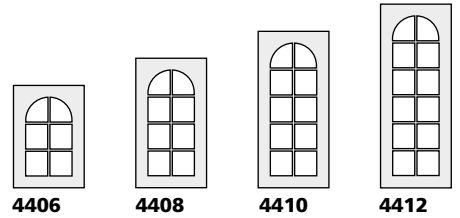

**4406**   **4408**   **4410**   **4412**



Model **4106**  
Color: V67WT

## Specials

### SERIES 6300-6400

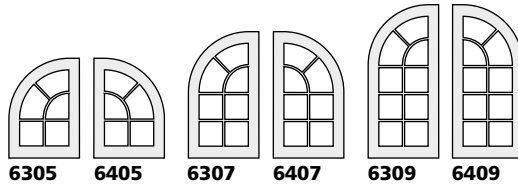

**6305**   **6405**   **6307**   **6407**   **6309**   **6409**

### SERIES 6700

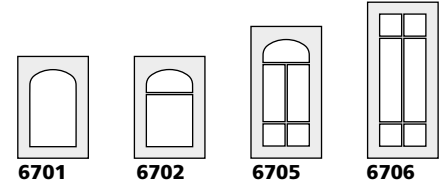

**6701**   **6702**   **6705**   **6706**

### SERIES 6500-6600

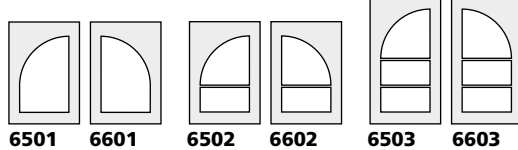

**6501**   **6601**   **6502**   **6602**   **6503**   **6603**

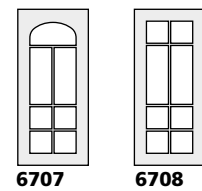

**6707**   **6708**

### SERIES 6900

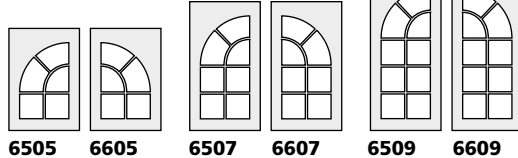

**6505**   **6605**   **6507**   **6607**   **6509**   **6609**

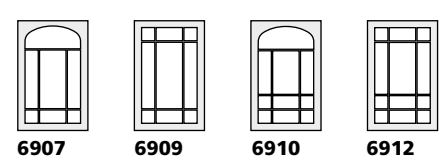

**6907**   **6909**   **6910**   **6912**

# FRAME AND MULLION DOORS

## OPTION:

MDF core will be visible on the back of the frame or mullion door. It can be painted on request.

## SPECIFICATIONS

- 1) For special frame and mullion doors (except series 6900), the door widths must be identical.
- 2) An interior profile must be specified for frame and mullion doors ordered with models 00, 79, 80, 910 (default profile 51) and 911, 912 (default profile 09).
- 3) Series 83 to 89 are only available in special mullion door models 6706, 6708, 6909 and 6912. This restriction does not apply to series 93 to 99.
- 4) Models 942 and 996 frame and mullion doors are available only in 4100 series.

## Glass insert sizes

| Model   | Height  |            | Width   |            |
|---|---------|------------|---------|------------|
|   | mm      | inches     | mm      | inches     |
| 01-03-04-06-07-27-31-33-46-71-73-974  | H - 115 | H - 4 1/2  | W - 115 | W - 4 1/2  |
| 08-09-32-39-47-48-49-50-51-52-55-56-58-70-72-76-77-78-83-85-86-87-88-89-93-95-96-97-98-99-167-767-942-972 | H - 102 | H - 4      | W - 102 | W - 4      |
| 921-922-924   | H - 91  | H - 3 9/16 | W - 127 | W - 5      |
| 923   | H - 91  | H - 3 9/16 | W - 163 | W - 6 7/16 |
| 996   | H - 88  | H - 3 1/2  | W - 102 | W - 4      |
| 41-61-62-65-66-164-764  | H - 127 | H - 5      | W - 127 | W - 5      |

H = Height W = width

## SPECIFICATIONS

Suggested glass thickness: 3 mm (1/8") to 5 mm (3/16").

For glass over 1219 mm (48"), glass thickness of 5 mm (3/16") is suggested.

## Glass Retainer Moulding

| Model | Colors |
|-------|--------|
| 5351  | Clear  |
| 5350  | White  |



## GLASS INSTALLATION

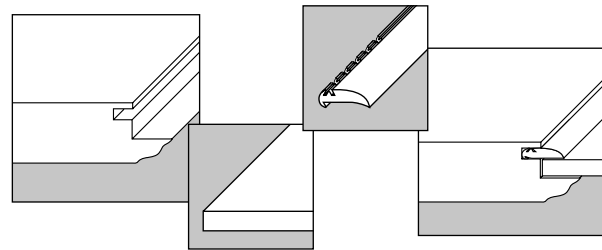

## Minimum dimensions

| Lites | Height x Width |             |
|-------|----------------|-------------|
|       | mm             | inches      |
| 01    | 203.2 x 203.2  | 8 x 8       |
| 02    | 279.4 x 203.2  | 11 x 8      |
| 03    | 368.3 x 203.2  | 14 1/2 x 8  |
| 04    | 279.4 x 279.4  | 11 x 11     |
| 06    | 368.3 x 279.4  | 14 1/2 x 11 |
| 08    | 457.2 x 279.4  | 18 x 11     |
| 10    | 546.1 x 279.4  | 21 1/2 x 11 |
| 12    | 635.0 x 279.4  | 25 x 11     |

| Lites | Height x Width |
|-------|----------------|
| 01    | *              |
| 02    | ≥ W            |
| 03    | ≥ 1.4 x W      |
| 04    | ≥ W            |
| 06    | ≥ 1.4 x W      |
| 08    | ≥ 1.8 x W      |
| 10    | ≥ 2.2 x W      |
| 12    | ≥ 2.6 x W      |

\* Frames 4401 have the same minimum dimensions as their corresponding door model (ex.: 401, etc.).

| Series      | Width     |
|-------------|-----------|
| 6305 - 6405 | ≥ 1.4 x W |
| 6307 - 6407 | ≥ 1.6 x W |
| 6309 - 6409 | ≥ 2 x W   |
| 6501 - 6601 | ≥ W       |
| 6502 - 6602 | ≥ 1.4 x W |
| 6503 - 6603 | ≥ 1.6 x W |
| 6505 - 6605 | ≥ 1.4 x W |
| 6507 - 6607 | ≥ 1.6 x W |
| 6509 - 6609 | ≥ 2.0 x W |

The center of the radius is not calculated from the door rail. Please contact Customer Service for more information.

| Series | Width     |
|--------|-----------|
| 6701   | ≥ 0.6 x W |
| 6702   | ≥ 0.9 x W |
| 6705   | ≥ 1.5 x W |
| 6706   | ≥ 1.5 x W |
| 6707   | ≥ 1.9 x W |
| 6708   | ≥ 1.9 x W |

| Series | Height x Width |                   |
|--------|----------------|-------------------|
| 6907   | 500 x 444.5    | 19 11/16 x 17 1/2 |
| 6909   | 425 x 444.5    | 16 3/4 x 17 1/2   |
| 6910   | 600 x 444.5    | 23 5/8 x 17 1/2   |
| 6912   | 525 x 444.5    | 20 11/16 x 17 1/2 |

## Multiple Panels

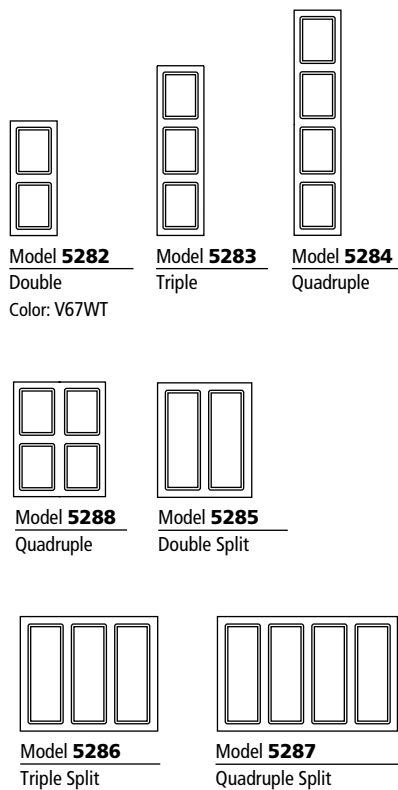

## Appliance Panels

Appliance panels are available in the same models as the doors and multiple panels. However, their exterior is modified, as shown, to simplify their insertion.

Exterior profile **A** in this example.  
Available exterior profiles: A, B, C, F, I, J, L, Y

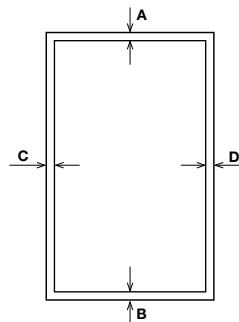
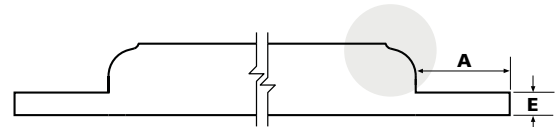

### SPECIFICATIONS

Values from **A** to **E** must be specified. If not specified, default value for **E** will be 6.35 mm (1/4"). Minimum thickness for **E** is 4.76 mm (3/16").

### AVAILABLE MODELS

- Simple (5270)
- Double (5272)
- Double Split (5275)
- Triple (5273)
- Triple Split (5276)
- Quadruple (5274, 5278)
- Quadruple Split (5277)

Model **5270**  
Simple

## Frame for built-in appliances



Model **5566**  
Color: R205W

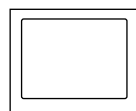

Model **5560**

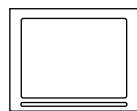

Model **5561**

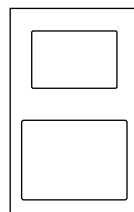

Model **5567**

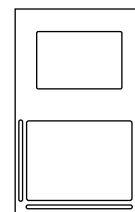

Model **5569**

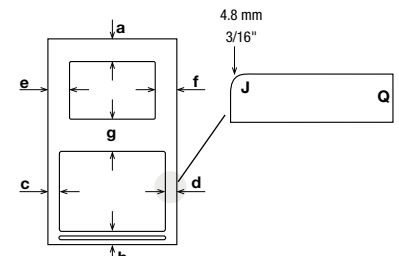

Model **5568**

### SPECIFICATIONS

- 1) Inner and outer frame are available in all exterior profiles. Profiles by default are **J** for the interior profile and **Q** for the exterior profile.
- 2) Vents are centered on the height and width of the rail.
- 3) Minimum rails dimensions:
  - with vent, 50 mm (2");
  - without vent, 38.1 mm (1 1/2")
- 4) For models 5567, 5568 and 5569, please specify at least 1 opening height.



# MOULDINGS AND ACCESSORIES

## Thermoplastic Laminated Panels

### Laminated particle board panels – Unilam (Phenolic paper)

#### ONE SIDE: THERMO FRONT / UNILAM BACK

- 5011 : 15.86 mm x 1.2 m x 2.7 m (5/8" x 4' x 9')
- 5013 : 15.86 mm x 1.2 m x 2.4 m (5/8" x 4' x 8')
- 5015 : 19.05 mm x 1.2 m x 2.4 m (3/4" x 4' x 8')

#### BOTH SIDES: THERMO FRONT / THERMO BACK

- 5010 : 15.86 mm x 1.2 m x 2.7 m (5/8" x 4' x 9')
- 5012 : 15.86 mm x 1.2 m x 2.4 m (5/8" x 4' x 8')
- 5019 : 19.05 mm x 1.2 m x 2.4 m (3/4" x 4' x 8')

### Laminated MDF Panels – MDF (one side)

#### THERMO FRONT / RAW MDF BACK

- 5014 : 6.3 mm x 1.2 m x 2.4 m (1/4" x 4' x 8')
- 5018 : 3.18 mm x 1.2 m x 2.4 m (1/8" x 4' x 8')
- 5027 : 19.05 mm x 1.2 m x 2.7 m (3/4" x 4' x 9')

### Laminated MDF Panels (Both sides)

#### THERMO FRONT / THERMO BACK

- 5017 : 19.05 mm x 1.2 m x 2.7 m (3/4" x 4' x 9')
- 5026 : 15.86 mm x 1.2 m x 2.4 m (5/8" x 4' x 8')

### Laminated Melamine Panels – Melamine (one side)

#### THERMO FRONT / MELAMINE BACK

- 5016 : 19.05 mm x 1.2 m x 2.7 m (3/4" x 4' x 9')
- 5024 : 15.86 mm x 1.2 m x 2.7 m (5/8" x 4' x 9')
- 5025 : 15.86 mm x 1.2 m x 2.4 m (5/8" x 4' x 8')

Note: See pages 47-48 for specifications and colors availability.

## Wine Racks

### CIRCLE OPENINGS



Model **5132**  
Color: F435WT



Model **5133**  
Color: F435WT

### SPECIFICATIONS

- If models 5132 and 5133 are paired together, it must be specified when placing your order.
- Minimum dimensions:  
5132: 76.2 mm (3") height  
5133: 69.8 mm (2 3/4") height



Model **5134**  
Color: F435WT

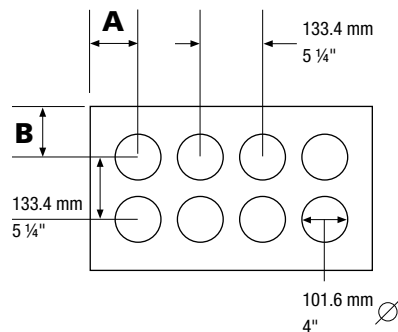

### SPECIFICATIONS

- 1) Standard opening diameter: 101.6 mm (4")
- 2) Distance from the center of one opening to the center of the next.: 133.4 mm (5 1/4")
- 3)  $A = \frac{\text{Width} - (\text{number of holes} - 1) \times 133.4 \text{ mm}}{\text{Width} - (\text{number of holes} - 1) \times 5 \frac{1}{4} \text{''}} \div 2$   
 $B = \frac{\text{Height} - (\text{number of holes} - 1) \times 133.4 \text{ mm}}{\text{Height} - (\text{number of holes} - 1) \times 5 \frac{1}{4} \text{''}} \div 2$
- 4) **A** or **B** minimum dimension: 76.2 mm (3")

Model **5138**  
Color: F435WT

### DIAMOND OPENINGS



Model **5141**  
Color: R205W



Model **5142**  
Color: R205W



Model **5143**  
Color: R205W

### SPECIFICATIONS

Opening size: 101.6 x 101.6 mm (4" x 4")

| Product          | Number of openings | Minimum dimension |        | Maximum dimension |        |
|------------------|--------------------|-------------------|--------|-------------------|--------|
|                  |                    | mm                | in.    | mm                | in.    |
| <b>5134/5138</b> | 1                  | 152.4             | 6      | 285.7             | 11 1/4 |
|                  | 2                  | 285.8             | 11 1/4 | 419.0             | 16 1/2 |
|                  | 3                  | 419.1             | 16 1/2 | 501.6             | 19 3/4 |
|                  | 4                  | 552.5             | 21 3/4 | 685.7             | 27     |
|                  | 5                  | 685.8             | 27     | 819.1             | 32 1/4 |
|                  | 6                  | 819.2             | 32 1/4 | 952.4             | 37 1/2 |
| <b>5141/5142</b> | 1                  | 239.4             | 9 3/8  | 427.9             | 16 7/8 |
|                  | 2                  | 428.0             | 16 7/8 | 616.5             | 24 1/4 |
|                  | 3                  | 616.6             | 24 1/4 | 805.0             | 31 3/4 |
|                  | 4                  | 805.1             | 31 3/4 | 993.6             | 39 1/8 |
|                  | 5                  | 993.7             | 39 1/8 | 1182.2            | 46 1/2 |
|                  | 6                  | 1182.3            | 46 1/2 | 1370.8            | 54     |
| <b>5143</b>      | 1                  | 194.5             | 7 3/8  | 383.0             | 15 1/8 |
|                  | 2                  | 383.1             | 15 1/8 | 571.6             | 22 1/2 |
|                  | 3                  | 571.7             | 22 1/2 | 760.1             | 29 7/8 |
|                  | 4                  | 760.2             | 29 7/8 | 948.7             | 37 3/8 |
|                  | 5                  | 948.8             | 37 3/8 | 1137.3            | 44 3/4 |
|                  | 6                  | 1137.4            | 44 3/4 | 1325.9            | 52 1/4 |

# MOULDINGS AND ACCESSORIES

## Decorative Mouldings

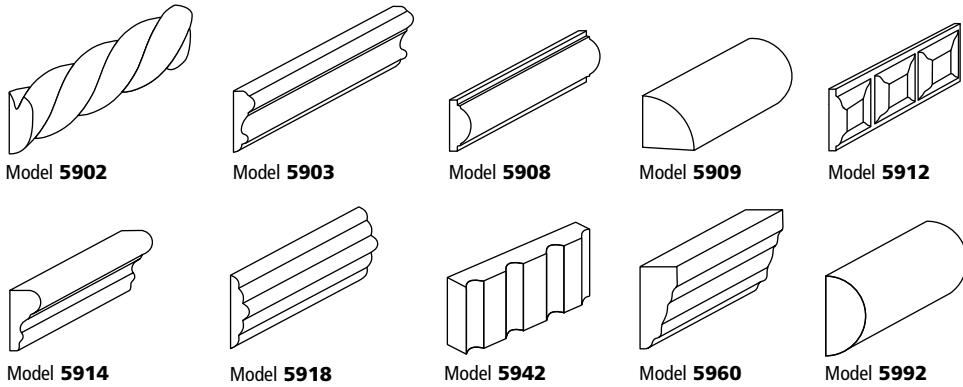

| Model | Height x Thickness |              |
|-------|--------------------|--------------|
|       | mm                 | inches       |
| 5767  | 40.6 x 15.2        | 1 5/8 x 5/8  |
| 5902  | 17.5 x 7           | 11/16 x 9/32 |
| 5903  | 20.6 x 6.4         | 13/16 x 1/4  |
| 5908  | 19 x 8             | 3/4 x 5/16   |
| 5909  | 19 x 19            | 3/4 x 3/4    |
| 5912  | 22.2 x 8           | 7/8 x 5/16   |
| 5914  | 25.4 x 12          | 1 x 15/32    |
| 5918  | 27 x 6.4           | 1 1/16 x 1/4 |
| 5942  | 25.4 x 19          | 1 x 3/4      |
| 5960  | 35 x 16            | 1 3/8 x 5/8  |
| 5992  | 38 x 19            | 1 1/2 x 3/4  |

### SPECIFICATIONS

- 1) Available in 2.4 m (8') lengths.
- 2) Definition of certain details varies according to the thickness of the thermoplastic foil.
- 3) Models 5902 and 5912 come in 2.38 m (94") lengths.

## Trim Moulding

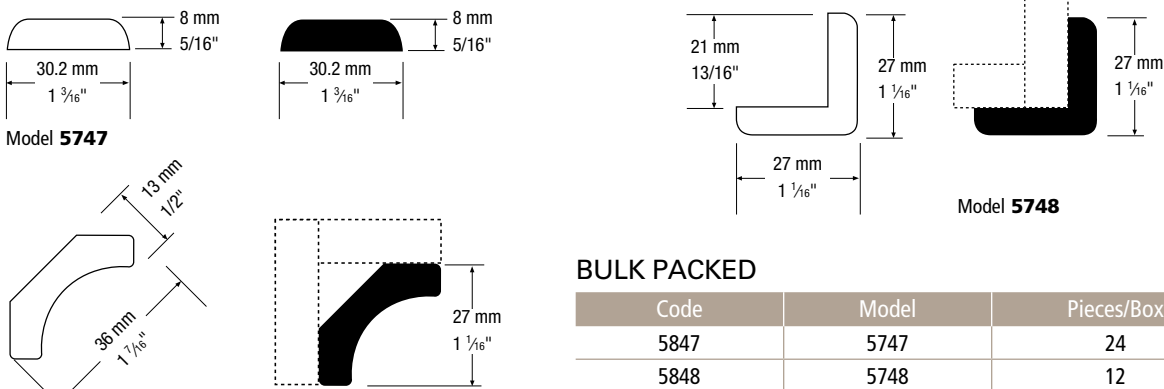

### BULK PACKED

| Code | Model | Pieces/Box |
|------|-------|------------|
| 5847 | 5747  | 24         |
| 5848 | 5748  | 12         |
| 5858 | 5758  | 2          |

NOTE: Certain Color restrictions apply. Please consult price list.

## Decorative moulding

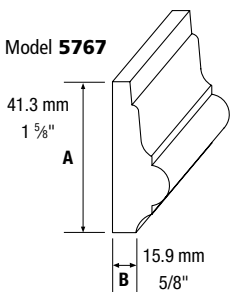

Model 5767

## Decorative Base

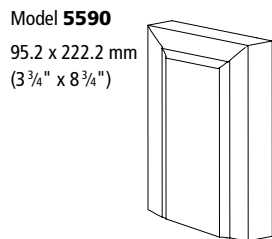

Model 5590  
95.2 x 222.2 mm  
(3 3/4" x 8 3/4")

## Decorative corner

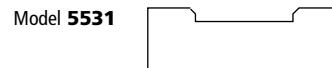

Model 5531

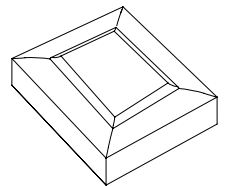

Model 5540  
95.2 x 95.2 mm  
(3 3/4" x 3 3/4")

### Minimum dimensions

| Decorative corner Height x Thickness |             |        |
|--------------------------------------|-------------|--------|
| Épaisseur                            | mm          | inches |
| 3/4"                                 | 76.2 x 76.2 | 3 x 3  |
| 1"                                   | 76.2 x 76.2 | 3 x 3  |

## Baseboards

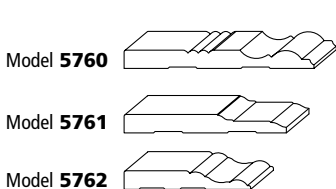

| Model | Height x Thickness |             |
|-------|--------------------|-------------|
|       | mm                 | inches      |
| 5760  | 165.1 x 15.2       | 6 1/2 x 5/8 |
| 5761  | 139.7 x 15.2       | 5 1/2 x 5/8 |
| 5762  | 108 x 15.2         | 4 1/4 x 5/8 |

## Frame mouldings

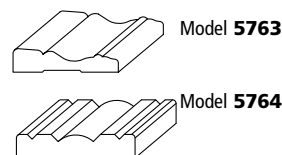

| Model | Height x Thickness |               |
|-------|--------------------|---------------|
|       | mm                 | inches        |
| 5763  | 68.3 x 15.2        | 2 11/16 x 5/8 |
| 5764  | 79.4 x 15.2        | 3 1/8 x 5/8   |

# MOULDINGS AND ACCESSORIES

## Crown mouldings

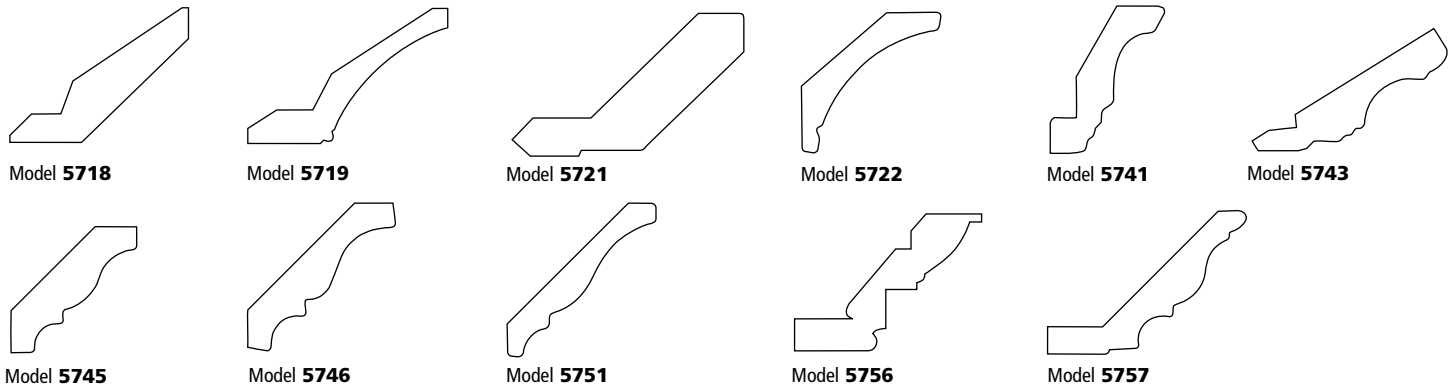

### Height x Thickness

| Model | mm             | inches          |
|-------|----------------|-----------------|
| 5718  | 99.1 x 24.6    | 3 15/16 x 3 1/2 |
| 5719  | 99.1 x 25      | 3 15/16 x 1     |
| 5721  | 65.1 x 19.1    | 2 9/16 x 3/4    |
| 5722  | 102.25 x 31.71 | 4 x 3/4         |
| 5741  | 76.2 x 17.5    | 3 x 1 1/16      |
| 5743  | 90.5 x 17.5    | 3 9/16 x 1 1/16 |
| 5745  | 69.9 x 17      | 2 3/4 x 43/64   |
| 5746  | 80.2 x 17.5    | 3 5/32 x 1 1/16 |
| 5751  | 108 x 15       | 4 1/4 x 19/32   |
| 5756  | 88.9 x 19.1    | 3 1/2 x 3/4     |
| 5757  | 139.7 x 30     | 5 1/2 x 1 1/64  |

### SPECIFICATIONS

- Available in 2.4 m (8') lengths.
- Available in all colors.

### BULK PACKED

| Code | Model | Pieces/Box |
|------|-------|------------|
| 5841 | 5741  | 4          |
| 5843 | 5743  | 4          |
| 5845 | 5745  | 4          |
| 5846 | 5746  | 4          |
| 5856 | 5756  | 2          |
| 5857 | 5757  | 2          |

Note: some Color restrictions apply.  
Please consult price list.

## Installation

### METHOD 1

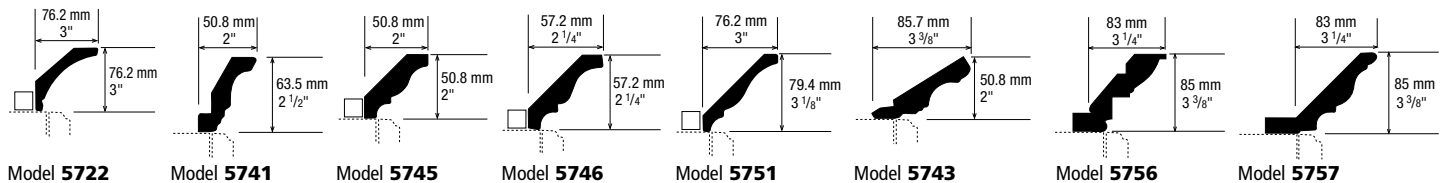

### METHOD 2

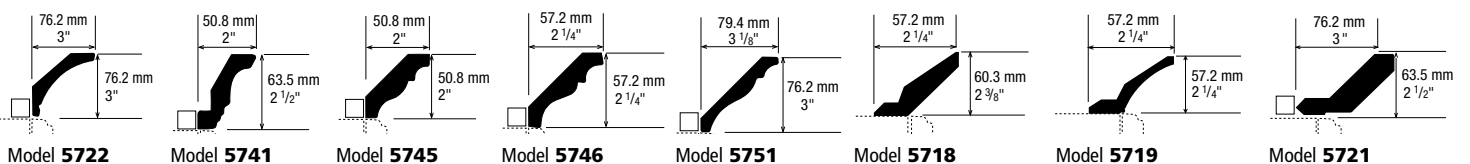

Crown mouldings should be glued and clamped rather than nailed.

# MOULDINGS AND ACCESSORIES

## 3" Standard Valances

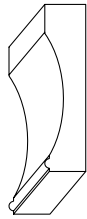
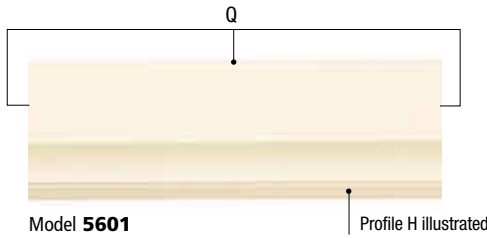

### SPECIFICATIONS

- 1) Standard valances are 76.2 mm (3") high with the bottom edge profiled.
- 2) All exterior profiles are available. (See page 2)
- 3) 5601 (profiled 1 side), 5602 (profiled 2 sides) = 76.2 mm (3")
- 4) Woodgrain direction is horizontal.

- 5) To order flat customized fillers, base mouldings or valances, order product 2000 and 3000.
- 6) Minimum charge of 0.19 sq.m (2 sq.ft) for thermoplastic valances whose height or width is less than 76.2 mm (3") and whose length is greater than 1828 mm (72").

## Custom Valances



Model **5610**  
Color: C72R



Model **5620**  
Color: C72R



Model **5631**  
Color: C72R



Model **5640**  
Color: C72R



Model **5650**  
Color: C72R

## Valances (Designer Series)



Model **5510**  
Country Manor

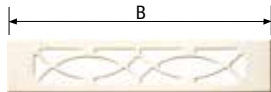

Model **5520**  
Country Cottage

| Model                | Minimum dimensions |     |       |       | Standard dimensions |     |     |     |
|----------------------|--------------------|-----|-------|-------|---------------------|-----|-----|-----|
|                      | A                  |     | B     |       | A                   |     | B   |     |
|                      | mm                 | in. | mm    | in.   | mm                  | in. | mm  | in. |
| 5510 Country Manor   | 152                | 6   | 235   | 9 1/4 | 152                 | 6   | 762 | 30  |
| 5520 Country Cottage | 152                | 6   | 304.8 | 12    | 152                 | 6   | 762 | 30  |

### SPECIFICATIONS

- 1) Back routing is identical to frame and mullion doors.
- 2) Model 5520 "Eye Shaped" pattern repeated every 355.6 mm (14").
- 3) All profiles available except D, F, H and P.
- 4) If width < 44", woodgrain direction is vertical.
- 5) If width > 44", woodgrain direction is horizontal.

## Standards

Custom valance standard dimensions have been established as shown below.

Therefore, custom valances ordered outside of these standards will require special programming.

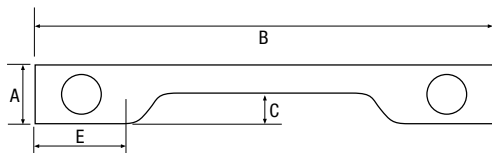

Models **5610-5611-5616**

- If  $B < 609.6$  mm (24"),  $E = 76.2$  mm (3")
- If  $B \geq 609.6$  mm (24"),  $E = 152.4$  mm (6")
- If  $A < 203.2$  mm (8"),  $C = 50.8$  mm (2")
- If  $A \geq 203.2$  mm (8"),  $C = 101.6$  mm (4")

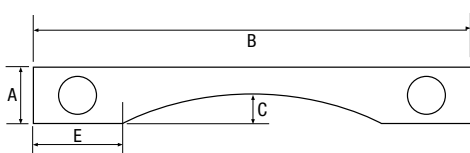

Models **5620-5621-5626, 5630-5631-5636**

- $E$  is variable
- If  $B < 508$  mm (20"),  $E$  minimum size is 76.2 mm (3") and  $E$  maximum size is 101.6 mm (4")
- If  $B \geq 508$  mm (20"),  $E$  minimum size is 76.2 mm (3") and  $E$  maximum size is 165.1 mm (6 1/2")
- If  $A < 203.2$  mm (8"),  $C = 50.8$  mm (2")
- If  $A \geq 203.2$  mm (8"),  $C = 101.6$  mm (4")

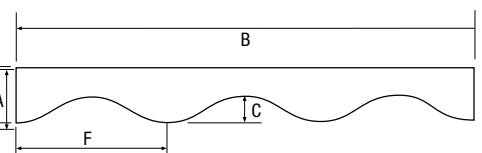

Models **5640**

- If  $B < 762$  mm (30"),  $F = 127$  mm (5") and  $C = 25.4$  mm (1")
- If  $B \geq 762$  mm (30"),  $F = 254$  mm (10") and  $C = 50.8$  mm (2")

### Minimum dimensions

| Model                       | A     |     | B     |     |
|-----------------------------|-------|-----|-------|-----|
|                             | mm    | in. | mm    | in. |
| 5610 plain                  | 101,6 | 4   | 330,2 | 13  |
| 5611 with 2 routed circles  | 101,6 | 4   | 330,2 | 13  |
| 5616 with 2 applied rosette | 101,6 | 4   | 330,2 | 13  |
| 5620 plain                  | 101,6 | 4   | 304,8 | 12  |

| Model                       | A     |     | B     |     |
|-----------------------------|-------|-----|-------|-----|
|                             | mm    | in. | mm    | in. |
| 5621 with 2 routed circles  | 101,6 | 4   | 304,8 | 12  |
| 5626 with 2 applied rosette | 101,6 | 4   | 304,8 | 12  |
| 5630 plain                  | 101,6 | 4   | 304,8 | 12  |
| 5631 with 2 routed circles  | 101,6 | 4   | 304,8 | 12  |

| Model                       | A     |     | B     |     |
|-----------------------------|-------|-----|-------|-----|
|                             | mm    | in. | mm    | in. |
| 5636 with 2 applied rosette | 101,6 | 4   | 304,8 | 12  |
| 5640 plain                  | 101,6 | 4   | 254   | 10  |
| 5650 plain                  | 101,6 | 4   | 152,4 | 6   |

### SPECIFICATIONS

- 1) Only the bottom edge is profiled. Please specify the edge profile.
- 2) Rosettes are centred vertically in the  $A$  dimension and horizontally in the  $E$  dimension.
- 3) Woodgrain pattern is horizontal. (Exeptions may apply, please contact Customer Service for further information.)

# MOULDINGS AND ACCESSORIES

## Rosettes



Model **5530**  
Color: C72R



Model **5580**  
Color: C72R

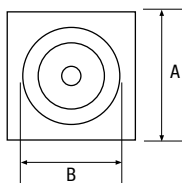

### Standard dimensions

| Model                | A    |     | B    |         | C         |         |
|----------------------|------|-----|------|---------|-----------|---------|
|                      | mm   | in. | mm   | in.     | mm        | in.     |
| 5530 circle route    | 76.2 | 3   | 68   | 2 11/16 | 19.1 – 25 | 3/4 – 1 |
| 5580 applied rosette | 76.2 | 3   | 63.5 | 2 1/2   | 19.1 – 25 | 3/4 – 1 |

### SPECIFICATIONS

- 1) Not available with exterior profiles: **H**, **P** and **V**.
- 2) A minimum of 88.9 mm (3 1/2") is required for all profiles except **Q** and **Y**.
- 3) Available with white back only.

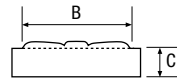
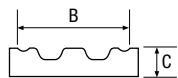

## 3" Radius Corners



Model **5300** Standard lengths 800 mm (31 1/2")

Model **5310** Standard lengths 2440 mm (96")

### SPECIFICATIONS

- 1) Standard lengths: 800 mm (31 1/2"), 2440 mm (96"). Custom lengths also available as an option.

## Shaker Filler

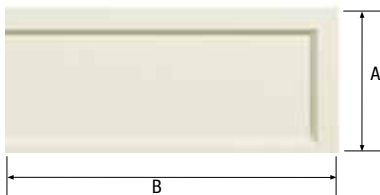

Model **5450**  
Color: C72R

### Standard dimensions

| Model | A    |     | B   |     |
|-------|------|-----|-----|-----|
|       | mm   | in. | mm  | in. |
| 5450  | 76.2 | 3   | 813 | 32  |

### SPECIFICATIONS

- 1) Default exterior profile: **Q**.
- 2) Not available with exterior profiles: **H**, **P** and **V**.
- 3) Different lengths are available on request for **A** and **B**.

## Fillers



### Standard dimensions

| Model | Description                                | A    |     | B     |       | C   |     | D     |     | E    |     | F    |         |
|-------|--|------|-----|-------|-------|-----|-----|-------|-----|------|-----|------|---------|
|       |  | mm   | in. | mm    | in.   | mm  | in. | mm    | in. | mm   | in. | mm   | in.     |
| 5400  | plain                                      | 76.2 | 3   | –     | –     | 813 | 32  | –     | –   | –    | –   | –    | –       |
| 5401  | with 2 routed circles                      | 76.2 | 3   | 114.3 | 4 1/2 | 813 | 32  | –     | –   | –    | –   | 68   | 2 11/16 |
| 5406  | with 2 applied rosettes                    | 76.2 | 3   | 114.3 | 4 1/2 | 813 | 32  | –     | –   | –    | –   | 63.5 | 2 1/2   |
| 5410  | 1 staggered groove                         | 76.2 | 3   | –     | –     | 813 | 32  | –     | –   | 50.8 | 2   | –    | –       |
| 5411  | 1 staggered groove with 2 routed circles   | 76.2 | 3   | 114.3 | 4 1/2 | 813 | 32  | 177.8 | 7   | 50.8 | 2   | 68   | 2 11/16 |
| 5416  | 1 staggered groove with 2 applied rosettes | 76.2 | 3   | 114.3 | 4 1/2 | 813 | 32  | 177.8 | 7   | 50.8 | 2   | 63.5 | 2 1/2   |
| 5420  | 2 grooves                                  | 76.2 | 3   | –     | –     | 813 | 32  | 177.8 | 7   | –    | –   | –    | –       |
| 5421  | 2 grooves with 2 routed circles            | 76.2 | 3   | 114.3 | 4 1/2 | 813 | 32  | 177.8 | 7   | –    | –   | 68   | 2 11/16 |
| 5426  | 2 grooves with 2 applied rosettes          | 76.2 | 3   | 114.3 | 4 1/2 | 813 | 32  | 177.8 | 7   | –    | –   | 63.5 | 2 1/2   |
| 5429  | 2 full length grooves                      | 76.2 | 3   | –     | –     | 813 | 32  | –     | –   | –    | –   | –    | –       |
| 5430  | 3 grooves                                  | 76.2 | 3   | –     | –     | 813 | 32  | 177.8 | 7   | –    | –   | –    | –       |
| 5431  | 3 grooves with 2 routed circles            | 76.2 | 3   | 114.3 | 4 1/2 | 813 | 32  | 177.8 | 7   | –    | –   | 68   | 2 11/16 |
| 5436  | 3 grooves with 2 applied rosettes          | 76.2 | 3   | 114.3 | 4 1/2 | 813 | 32  | 177.8 | 7   | –    | –   | 63.5 | 2 1/2   |
| 5439  | 3 full length grooves                      | 76.2 | 3   | –     | –     | 813 | 32  | –     | –   | –    | –   | –    | –       |

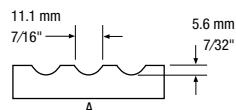
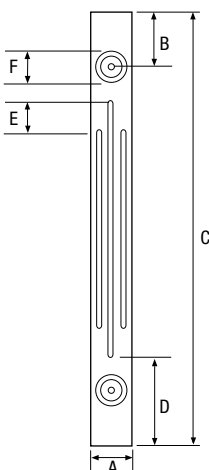

Note: If **C** is < 609,6 mm (24")

**B** = 38,1 mm (1 1/2")

**D** = 101,6 mm (4")

**E** = 25,4 mm (1")

### SPECIFICATIONS

- 1) Default exterior profile: **Q**.
- 2) Not available with exterior profiles: **H**, **P** and **V**.
- 3) The ratio is one groove per inch unless specified otherwise.
- 4) Different lengths are available on request for **A**, **B**, **C**, **D**, **E**.

# MOULDINGS AND ACCESSORIES

## Heatshield Fillers

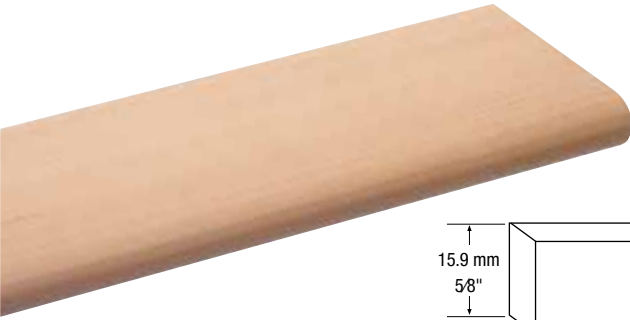

**Heatshield fillers** are high-heat-resistant fillers/spacers for kitchen cabinet installations near a heat source. **HPL Heatshield fillers** are postformed components with a 180° profile, subjected to pretesting at temperatures exceeding 120°C (250°F) without delamination

Produced with compatible HPL, they are available in most colors. Please contact Customer Service for an up-to-date list of available colors..

### SPECIFICATIONS

| Model | m   | in. |
|-------|-----|-----|
| 5315  | 1.2 | 4   |
| 5316  | 2.4 | 8   |

A 25.4 mm (1") HPL strip is supplied with each heatshield filler. After cutting the heatshield filler to size, use the edgebanding strip to finish the ends.

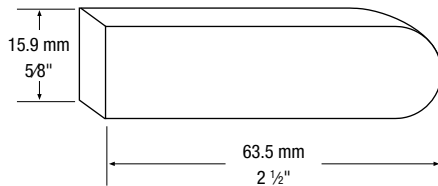

## Installation

### CLEAR PLASTIC HEATSHIELD FILLERS

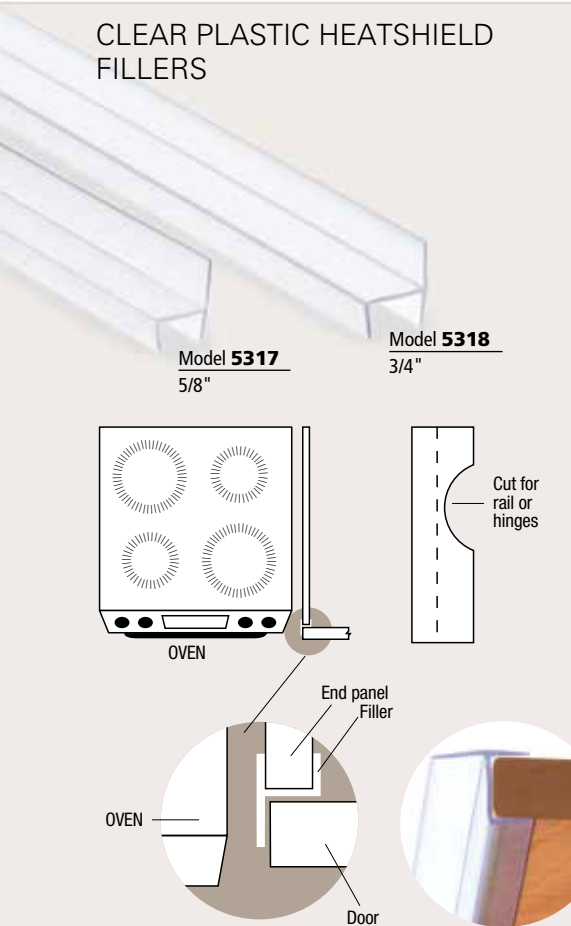

The clear plastic heatshield is a great option for cabinet installation close to a heat source. With the same resistance to heat as the HPL Heatshield fillers (250 °F / 120 °C), this clear plastic heatshield is compatible with all thermoplastic colors. It is easily installed along the edge of the end panel and requires no adhesive. If installing the heatshield around hinges or rails, a simple cut on the interior of the heatshield is sufficient.

### WALL MOUNTED OVENS

The use of heatshield fillers is recommended, as mentioned for base ovens and cooktops. In addition, a 5/8"-3/4" filler should be fitted horizontally between the oven and the top door, aligned with the door surface.

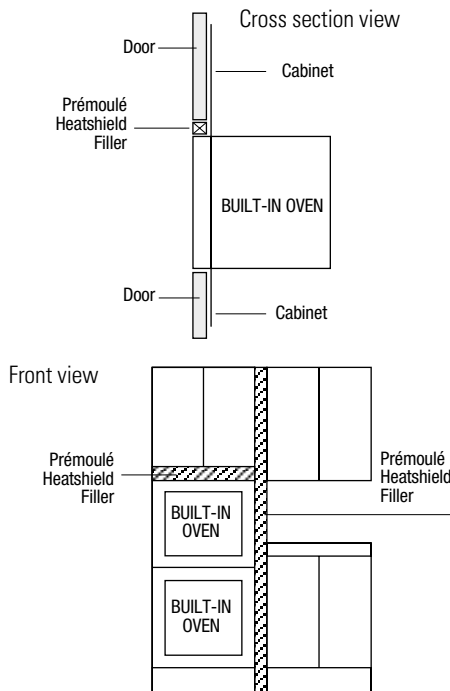

### BASE OVENS AND COOK TOPS

The heatshield filler must be mounted so that its surface is aligned with the adjacent door surface. The same recommendation applies to cook tops with front exhaust vents. The filler act as a shield against excessive radiant and convective heat associated with broiling (with the oven door open) and ovens with self-cleaning features.

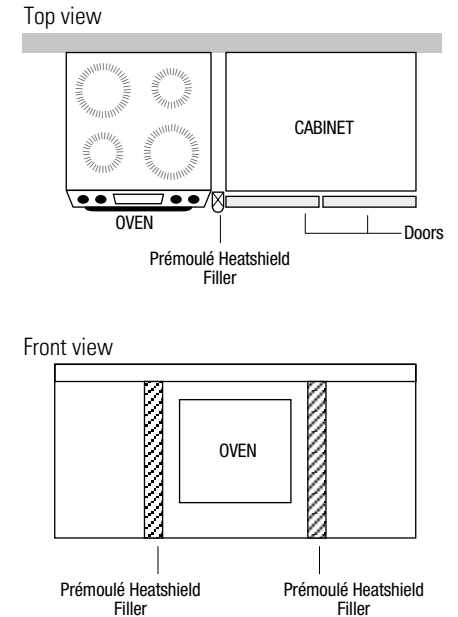

### WALL MOUNTED MICROWAVE OVENS AND UNDERMOUNT COFFEE MAKERS

The heatshield filler mounted flush, or protruding slightly beyond the face surfaces of doors above, is recommended. This precludes possible surface damage and swelling of core material from excessive heat and/or steam.

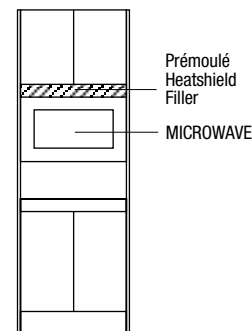

### RESTRICTION

**Counter top appliances:** Care must be taken when using toasters, toaster ovens, portable grills and other heat/steam generating appliances to ensure that upper cabinet doors are not subjected to excessive temperatures



# MOULDINGS AND ACCESSORIES

## Corner Shelves

### SHELF WITH RADIUS



Model **5120**

NOTE: Same Color melamine back available.

### SHELF WITH ELLIPSE



Model **5121**

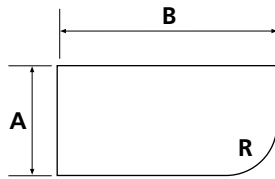

If **A** or **B** < 203.2 mm (8"), **R** = 88.9 mm (3 1/2")

If **A** and **B** ≥ 203.2 mm (8"), **R** = 190.5 mm (7 1/2")

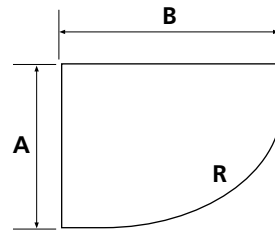

If **A** or **B** sizes are between:

101.6 mm (4") – 152.4 mm (6"), **R** = 101.6 mm (4")

152.4 mm (6") – 203.2 mm (8"), **R** = 152.4 mm (6")

203.2 mm (8") – 254 mm (10"), **R** = 203.2 mm (8")

254 mm (10") – 381 mm (15"), **R** = 254 mm (10")

NOTE: Minimum size for **A** and **B** is 89 mm (3 1/2")

## Decorative Tambours

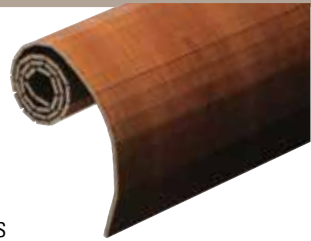

### Available dimensions

| Model Thickness<br>3.2 mm x 1/8 in. | Model Thickness<br>6.4 mm x 1/4 in. | m         | pi.   |
|-------------------------------------|-------------------------------------|-----------|-------|
| 5005                                | 5005                                | 0.6 x 0.6 | 2 x 2 |
| 5003                                | 5052                                | 0.6 x 1.2 | 2 x 4 |
| 5054                                | 5054                                | 1.2 x 1.2 | 4 x 4 |

### SPECIFICATIONS

- Strip width: 12.7 mm (1/2")  
First strip: 38.1 mm (1 1/2")
- The default woodgrain direction is vertical.  
Horizontal woodgrain available as an option.

## Thermoplastic Foil

Thermoplastic sheet  
Length must be specified

- 5000: 1.2 m (4') wide.

Peel and stick

- 5040: 1.2 m x 2.4 m (4' x 8')  
Length must be specify

Thermoplastic on phenolic

- 5060: 1.2 m x 2.4 m (4' x 8')

Note: See pages 47-48 for the available colors.

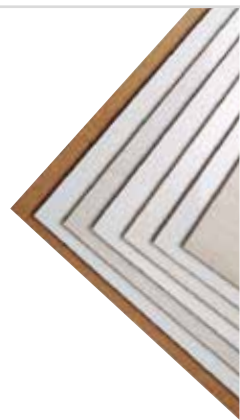

## Edgebanding

Our thermoplastic edgebanding is formulated to be used with edgebanding machines operating at 77 °C (170 °F). Since standard edgebanding machines run at 88 °C (190 °F) to 99 °C (210 °F), we also offer PVC edgebanding which can be applied with the standard machines. Available finishes for each type of edgebanding are listed in the table on page 47-48.

### Thermoplastic Edgebanding

- 25.4 mm (1") wide
- 100 m (328') roll (5008)
- 2.4 m (8') length (5009)

### PVC Edgebanding

- 23.8 mm (1 5/16") wide
- 236.2 m (600') roll (5050)

### SPECIFICATIONS

- Our warranty is applicable on thermoplastic products and does not apply to PVC edgebanding.
- If PVC edgebanding is applied manually, we recommend using a high quality water-based contact cement to avoid damaging adjacent thermoplastic surfaces.



## End Panels

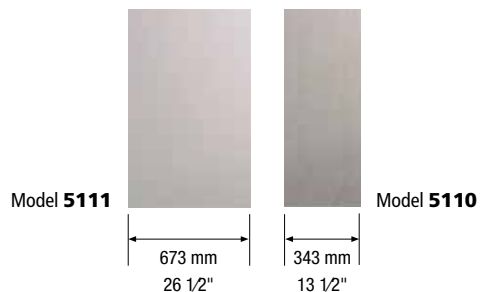

### Available dimensions

| Model<br>1 face | Model<br>2 faces | mm         | in.         |
|-----------------|------------------|------------|-------------|
| 5110            | 5116             | 343 x 2440 | 13 1/2 x 96 |
| 5111            | 5117             | 673 x 2440 | 26 1/2 x 96 |

### SPECIFICATIONS

- All exterior profiles available
- Custom dimensions also available.



# TECHNICAL SPECIFICATIONS

## Product Properties

### Height and width tolerance

- $\pm 0.5$  mm (0.020")

### Warp tolerance per linear foot

- $\pm 0,8$  mm (1/32"). Refer to page 47 for recommended hinge holes.

### Heat resistance

- 85 °C (185 °F). See page 44 for installation near heat sources.

## Product Care and Maintenance

Thermoplastic doors can be easily cleaned with mild soap and water. However, as with any quality product, there are certain precautions you can take to preserve its value.

- Avoid the use of harsh chemicals, such as lacquer thinner, bleach or cleansers containing solvents or abrasives; especially avoid products containing toluene or acetone.
- Avoid bumping or hitting surface with a sharp object, since it could result in a permanent indentation or cut. In the event of abuse, minor surface scratches can sometimes be removed depending on the severity of the damage. The following is recommended:
  - 1) Rub the scratched area with a high grade polishing compound.
  - 2) Polish the area with a caruba based wax.
  - 3) Repair kits are available from paint companies specializing in touch up paints.
- Avoid exposure of doors and drawers to high heat. To ensure against damage to doors or drawers, please do the following:
  - 1) When broiling with oven door open, open doors and drawers of adjacent cabinets to minimize exposure to high heat.
  - 2) Since the door seals on some ranges and ovens allow high heat to escape during the self cleaning cycle, as a precaution, open or remove doors and drawers of adjacent cabinets during the self cleaning cycle. Please read the warranty and instructions for your appliances.
  - 3) Be aware of countertop appliances such as boilers, toasters and toaster ovens that create high heat conditions. They should not be directly under doors of overhead cabinets while in use.

## Drawers fronts

We recommend ordering drawers fronts as doors rather than as reduced rails drawer fronts when they are over 228.6 mm (9") high.

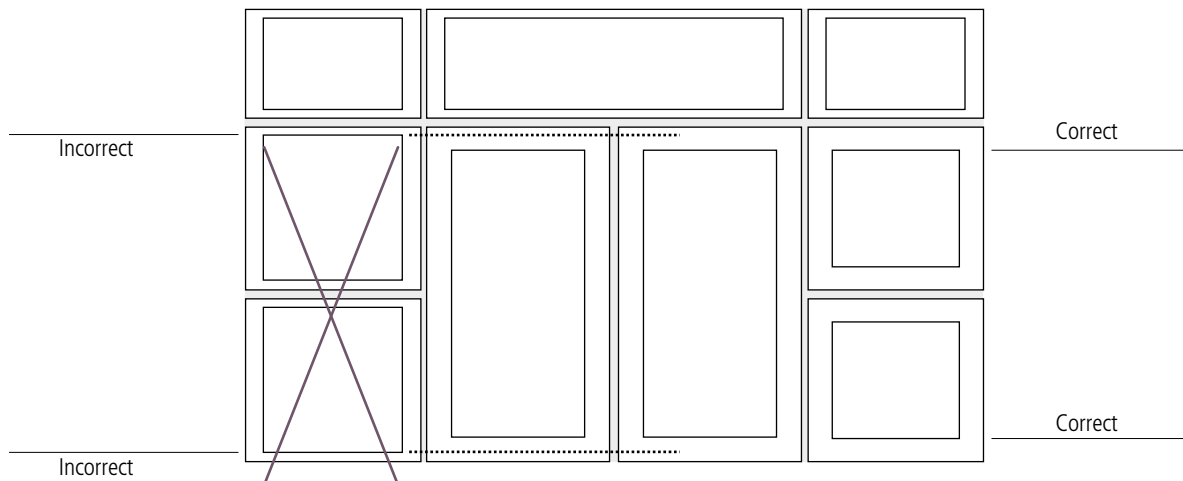

# TECHNICAL SPECIFICATIONS

## Fingerpull

The descriptive codes for fingerpull location have been simplified. (\*) in the new code correspond to the exterior profiles selected. Please replace the asterisk (\*) by the exterior profile letter.

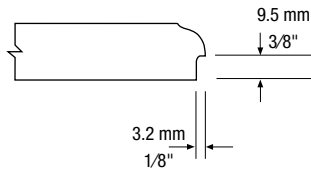

- 1) Can be added to all exterior profiles except **G, H, L, M** and **S**.
- 2) Fingerpulls 4\*\*\*, \*4\*\*, \*\*4\* and \*\*\*4 will be full length – starting 25.4 mm (1") from one side and ending 25.4 mm (1") from the other side.
- 3) All other fingerpulls will be 101.6 mm (4") wide. Fingerpulls on the corners will be 25.4 mm (1") from the end.

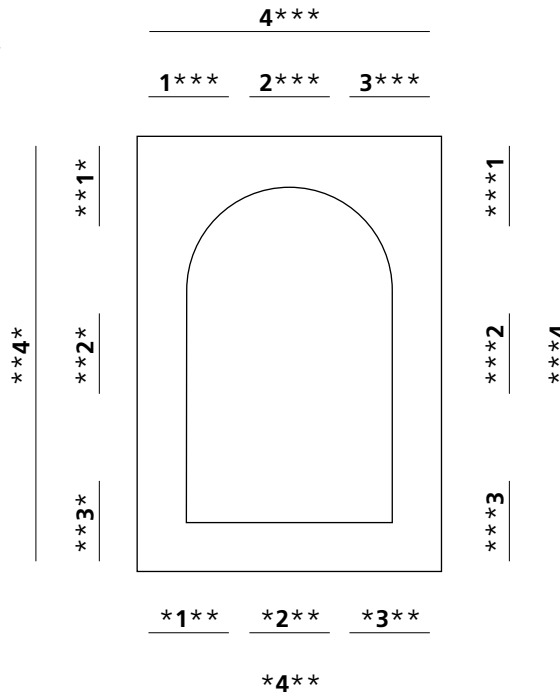

|      |                        |
|------|------------------------|
| 4*** | Top full length        |
| *4** | Bottom full length     |
| **4* | Left side full length  |
| ***4 | Right side full length |
| 1*** | Top left               |
| 2*** | Top centre             |
| 3*** | Top right              |
| *1** | Bottom left            |
| *2** | Bottom centre          |
| *3** | Bottom right           |
| **1* | Left side top          |
| **2* | Left side centre       |
| **3* | Left side bottom       |
| ***1 | Right side top         |
| ***2 | Right side centre      |
| ***3 | Right side bottom      |

## Quantity and Location of Hinges

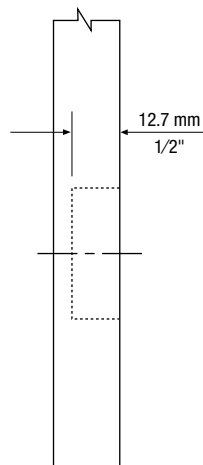
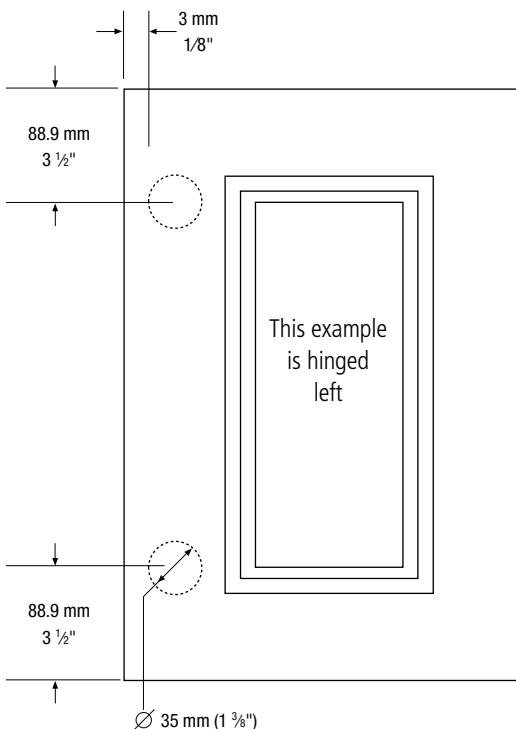

Standard hinge hole diameter: 35 mm (1 3/8")

Standard depth: 12.6 mm (1/2")

Standard location:

- for doors 254 mm (10") and over, 3 mm (1/8") from side and centred at 88.9 mm (3 1/2") from top or bottom edge of the door.
- for doors less than 254 mm (10"), 3 mm (1/8") from side and centred at 63.5 mm (2 1/2") from top or bottom edge of the door.

Note

For doors requiring more than 2 hinges, a drawing indicating actual position of the hinge holes is required.

| Door height<br>mm | Door height<br>inches | Number of hinges<br>required |
|-------------------|-----------------------|------------------------------|
| 0 to 899.16       | 0 to 35.4             | 2                            |
| 899.17 to 1000.8  | 35.5 to 39.4          | 3                            |
| 1000.9 to 1991.4  | 39.5 to 78.4          | 4                            |
| 1991.5 to 2438.4  | 78.5 to 96            | 5                            |

Minimum sizes indicated for each door model must be respected due to hinge clearance considerations.

# COLORS AND FINISHES

| Color         | Description                      | Color Group | Color Back           | Foil with Peel & Stick | Melamine                                   | HPL   | Heatshield fillers | Thermo Edge-banding | PVC Edge-banding |
|---------------|----------------------------------|-------------|----------------------|------------------------|--|---|--------------------|---------------------|------------------|
| <b>A31S</b>   | White - Super Matte              | B           | White - matte        | •                      | Uniboard 555                               | Arborite V7001-VR   |                    |                     | •                |
| <b>A3WT</b>   | Weekend Getaway - Textured       | B-C         | •                    | •                      | Tafisa M2003                               | T2003-VA<br>Arborite W476-EV                                | •                  |                     | •                |
| <b>A4WT</b>   | Winter Fun - Textured            | B-C         | •                    | •                      | Tafisa M2004                               | T2004-VA  |                    |                     | •                |
| <b>A15WT</b>  | Après-ski - Textured             | B-C         | •                    | •                      | Tafisa M2015                               | T2015-VA<br>Arborite W490-CW                                | •                  |                     | •                |
| <b>A24WT</b>  | Dalia ambassador - Textured      | B-C         | •                    | •                      | Uniboard K24                               | Uniboard K24  |                    |                     | •                |
| <b>A54WT</b>  | Skye - Textured                  | B-C         | •                    | •                      | Uniboard H54                               | Uniboard H54  |                    |                     | •                |
| <b>A60WT</b>  | Chiffon - Textured               | B-C         | •                    | •                      | Uniboard K60                               | Uniboard K60  |                    |                     | •                |
| <b>A61WT</b>  | Silk - Textured                  | B-C         | •                    | •                      | Uniboard K61                               | Uniboard K61  |                    |                     | •                |
| <b>A661S</b>  | Moon Light - Satin               | B-C         | •                    | •                      | Tafisa L761                                | Tafisa T761-KR<br>Formica 912-AN                            |                    |                     | •                |
| <b>B21R</b>   | White - Matte                    | A           | White - matte        | •                      | Arauco W400<br>Panolam S411<br>Tafisa L080 | Wilsonart D427-60   | •                  | •                   | •                |
| <b>B44W</b>   | Chocolate Pear Tree – Matte      | B-C         | •                    | •                      | Tafisa L4444                               |   |                    | •                   | •                |
| <b>B54W</b>   | Designer White Woodgrain - Matte | A           | White - matte        | •                      |  |   |                    | •                   |                  |
| <b>B175R</b>  | Snow White - Matte               | B           | White - matte        | •                      | Uniboard 5555<br>Panolam S557              | Formica 949-58*   | •                  |                     | •                |
| <b>C32L</b>   | Antique White - High Gloss       | F           | Antique white- matte | •                      |  | Formica 932-90<br>Wilsonart 1572-F1*                        | •                  | •                   | •                |
| <b>C35S</b>   | White - Satin                    | D           | White - matte        | •                      |  | Pionite SW826-SD  | •                  | •                   | •                |
| <b>C72R</b>   | Antique White - Matte            | A-AA        | •                    | •                      | Panolam S463<br>Uniboard 810               | Formica 932-58<br>Wilsonart 1572-60<br>Arborite S463-CA     | •                  | •                   | •                |
| <b>C72S</b>   | Antique White - Satin            | D-E         | •                    | •                      | Panolam S463<br>Uniboard 810               | Wilsonart 1572-07   | •                  | •                   |                  |
| <b>C73R</b>   | Frosty White - Matte             | A           | White - matte        | •                      | Arauco W100                                | Wilsonart 1573-60*  | •                  | •                   | •                |
| <b>C92W</b>   | Érable naturel - Mat             | B-C         | •                    | •                      | Uniboard 992<br>Panolam W290               | Wilsonart 10776-60<br>Pionite WM791-SD<br>Nevamar WM5528-SD | •                  | •                   | •                |
| <b>D530WT</b> | Latitude North - Textured        | B-C         | •                    | •                      | Tafisa L530                                | Tafisa T530-AT<br>Formica 8841-WR*                          | •                  |                     | •                |
| <b>F21W</b>   | Candlelight - Matte              | B-C         | •                    | •                      | Tafisa L421<br>Uniboard 262                | Pionite WW6001-SD   | •                  | •                   | •                |
| <b>F432WT</b> | Taction Oak Alabaster - Textured | B-C         | •                    | •                      | Arauco WF432                               | Formica WF432-NG  | •                  |                     | •                |
| <b>F434WT</b> | Taction Oak Gibraltar - Textured | B-C         | •                    | •                      | Arauco WF434                               | Formica WF434-NG<br>Pionite WY160-TL                        | •                  |                     | •                |
| <b>F435WT</b> | Taction Oak Palomino - Textured  | B-C         | •                    | •                      | Arauco WF435                               | Formica WF435-NG<br>Arborite W474-LE                        | •                  |                     | •                |
| <b>H109L</b>  | Grey HG – High Gloss             | F           | White - matte        | •                      |  |   |                    |                     | •                |
| <b>H110L</b>  | Taupe HG – High Gloss            | F           | White - matte        | •                      |  |   |                    |                     | •                |
| <b>K02W</b>   | Sesame - Satin                   | B-C         | •                    | •                      | Uniboard K02                               | Uniboard K02<br>Arborite W2009-AW                           |                    |                     | •                |
| <b>K16S</b>   | White - Super Matte              | B           | White - matte        | •                      | Arauco W100                                |   |                    |                     | •                |
| <b>K75S</b>   | Violet Grey - Satin              | B           | White - matte        | •                      |  |   |                    |                     | •                |
| <b>K85S</b>   | Mysterious Bleu - Satin          | B-C         | •                    | •                      | Arauco SF247                               | Panolam FB247   |                    |                     |                  |
| <b>K168S</b>  | Canadien Grey - Satin            | B-C         | •                    | •                      | Uniboard 168                               | Uniboard 168<br>Arborite S406-CA                            | •                  |                     | •                |
| <b>K233S</b>  | Gountlet Grey - Satin            | B-C         | •                    | •                      | Arauco SF233                               | Panolam FB233   | •                  |                     | •                |
| <b>K241S</b>  | Sienna - Satin                   | B-C         | •                    | •                      | Arauco SF230                               | Panolam FB430   | •                  |                     | •                |
| <b>K257S</b>  | Verde - Satin                    | B-C         | •                    | •                      | Arauco SF257                               | Panolam FB257   | •                  |                     | •                |
| <b>K464WT</b> | Urban Nomad - Textured           | B-C         | •                    | •                      | Arauco WF464                               | Wilsonart 8212K-28<br>Nevamar WU0030-WE                     | •                  |                     | •                |
| <b>K503S</b>  | Celadon Green - Satin            | B           | •                    | •                      | Arauco SF251                               | Panolam FB251   | •                  |                     | •                |
| <b>K636S</b>  | Fjord - Satin                    | B           | White - matte        | •                      |  |   |                    |                     | •                |
| <b>K961R</b>  | Stainless Steel - Matte          | D-E         | •                    | •                      | Uniboard 961<br>Panolam A60                | Uniboard 961  |                    | •                   | •                |

\* Stock Prémoulé

Shaded Color code indicates same Color back available. All other colors with white back.  
The ultimate responsibility rests solely with the end user with respect to acceptability of these options in specific applications.

# COLORS AND FINISHES

| Color           | Description                  | Color Group | Color Back    | Foil with Peel & Stick | Melamine                    | HPL   | Heatshield fillers | Thermo Edge-banding | PVC Edge-banding |
|-----------------|------------------------------|-------------|---------------|------------------------|-----------------------------|---|--------------------|---------------------|------------------|
| <b>P488W</b>    | Dolce Vita - Matte           | B-C         | •             | •                      | Tafisa L488                 | Tafisa T488-SN  |                    |                     | •                |
| <b>P489W</b>    | Copa Cabana - Matte          | B-C         | •             | •                      | Tafisa L489                 | Tafisa T489-SN<br>Arborite W486-CW  | •                  |                     | •                |
| <b>P492W</b>    | White Chocolate - Matte      | B-C         | •             | •                      | Tafisa L492                 | Tafisa T492-CR<br>Arborite W478-EV  | •                  |                     | •                |
| <b>P494W</b>    | Dark Chocolate - Matte       | B-C         | •             | •                      | Tafisa L494                 | Tafisa T494-CR  |                    |                     | •                |
| <b>P501WT</b>   | Linear Ash - Textured        | B-C         | •             | •                      | Arauco WF368                | Formica WF368-WR<br>Arborite W496-CW  | •<br>•             |                     | •                |
| <b>P909R</b>    | Black - Matte                | A-AA        | Black - matte |                        | Uniboard 888                | Formica 909-42 *<br>Arborite S405-CA<br>Wilsonart 1595-60<br>Pionite SE101-SD                     | •<br>•<br>•<br>•   | •                   |                  |
| <b>R32S</b>     | Black - Super Matte          | B-C         | Black - matte | •                      | Uniboard 888                | Formica 909-58 *  | •                  |                     | •                |
| <b>R42L</b>     | Black - High Gloss           | F           | Black - matte | •                      |                             | Arborite S405-GL<br>Formica 909-90*<br>Wilsonart 1595-F1  | •<br>•<br>•        |                     | •                |
| <b>R49L</b>     | White - High Gloss           | F           | White - matte | •                      |                             | Nevamar S7032-GL<br>Wilsonart 1573-F1*  | •<br>•             | •                   | •                |
| <b>R54R</b>     | Designer White - Matte       | A           | White - matte | •                      | Panolam S645                | Wilsonart D354-60*  | •                  | •                   | •                |
| <b>R74W</b>     | Mahogany - Matte             | B-C         | •             | •                      |                             | Nevamar WS9450-SD   | •                  | •                   | •                |
| <b>R80S</b>     | Celestine - Satin            | B-C         | •             | •                      | Uniboard K80                | Uniboard K80  |                    |                     | •                |
| <b>R81S</b>     | Adobe - Super Matte          | B           | White - matte | •                      | Uniboard K81                | Uniboard K81  |                    |                     | •                |
| <b>R82S</b>     | White Smoke - Super Matte    | B-C         | •             | •                      | Uniboard K82                | Uniboard K82<br>Formica 923-58  | •                  | •                   | •                |
| <b>R83S</b>     | Shipshaw - Super Matte       | B-C         | •             | •                      | Uniboard K83                | Uniboard K83  |                    | •                   | •                |
| <b>R89WT</b>    | Cosmos - Textured            | B-C         | •             | •                      | Uniboard K89                | Uniboard K89<br>Formica 8910-NG   | •                  |                     | •                |
| <b>R105S</b>    | White - Super Matte          | B           | White - matte | •                      | Tafisa L105                 | Tafisa T105-CR  |                    |                     | •                |
| <b>R205W</b>    | Tobacco Cherry - Matte       | B-C         | •             | •                      | Uniboard 205                | Uniboard 205<br>Pionite HP689-SD<br>Nevamar W8371-T   | •<br>•             | •                   | •                |
| <b>R207W</b>    | Choco Cherry - Matte         | B-C         | •             | •                      | Uniboard 207<br>Tafisa L807 | Uniboard 207<br>Tafisa T807-CR<br>Formica 7739-58<br>Arborite W415-FP                             | •<br>•             | •                   | •                |
| <b>R232S</b>    | Ashen - Satin                | B-C         | •             | •                      | Arauco SF232                | Formica SF232-58<br>Panolam FB432<br>Nevamar S2069-T  | •<br>•<br>•        |                     | •                |
| <b>R237S</b>    | Charcoal - Satin             | B           | White - matte | •                      | Arauco SF237                | Panolam FB237<br>Nevamar S6054-T  | •<br>•             |                     | •                |
| <b>R477W-DT</b> | Tuxedo - Matte               | B-C         | •             | •                      | Tafisa L477                 | Tafisa T477-CR  |                    |                     | •                |
| <b>R660S</b>    | Rain Cloud - Satin           | B-C         | •             | •                      | Tafisa L760                 | Tafisa T760-CR  |                    |                     | •                |
| <b>R663S</b>    | Morning Dew - Satin          | B-C         | •             | •                      | Tafisa L763                 | Tafisa T763-CR<br>Arborite S431-CA<br>Wilsonart 1500-60   | •<br>•             |                     | •                |
| <b>V66WT</b>    | Whisper - Textured           | B-C         | •             | •                      | Uniboard K66                | Uniboard K66<br>Arborite W485-CW  | •                  |                     | •                |
| <b>V67WT</b>    | Rumour - Textured            | B-C         | •             | •                      | Uniboard K67                | Uniboard K67<br>Wilsonart 8208K-16<br>Wilsonart 7981K-12<br>Pionite WA110-SD<br>Nevamar WX0075-AB | •<br>•<br>•<br>•   |                     | •                |
| <b>V202S</b>    | Summer Drops - Satin         | B-C         | •             | •                      | Tafisa L202                 | Tafisa T202-CR  |                    |                     | •                |
| <b>V285WT</b>   | Jazz Silk - Textured         | D           | White - matte | •                      |                             | Wilsonart 1595-18 *   | •                  |                     | •                |
| <b>V392WT</b>   | Licorice Groovz - Textured   | B-C         | •             | •                      | Arauco WF392                | Arauco WF392-NG   | •                  |                     | •                |
| <b>V393WT</b>   | Concrete Groovz - Textured   | B-C         | •             | •                      | Arauco WF393                | Arauco WF393-NG   | •                  |                     | •                |
| <b>V629R</b>    | Ivory - Matte                | A-AA        | •             | •                      | Tafisa L204                 | Tafisa T204-CR  |                    | •                   | •                |
| <b>V731V</b>    | Matte Luxe Viridian - Velvet | B           | White - matte | •                      |                             |   |                    |                     | •                |
| <b>V745V</b>    | Matte Luxe Black - Velvet    | B           | White - matte | •                      |                             | Nevamar S6053-SM  | •                  |                     | •                |

\* Stock Prémoulé

# COLORS AND FINISHES



**R54R**  
Designer White - Matte

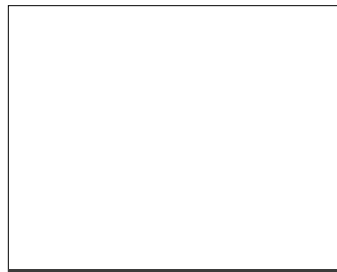

**C35S**  
White - Satin

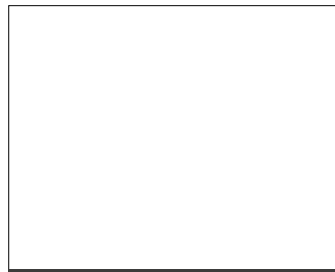

**R105S**  
White - Super Matte

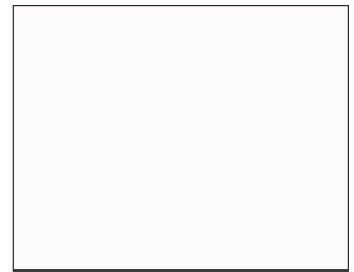

**R49L**  
White - High Gloss

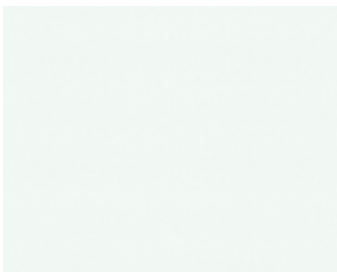

**K16S**  
White - Super Matte

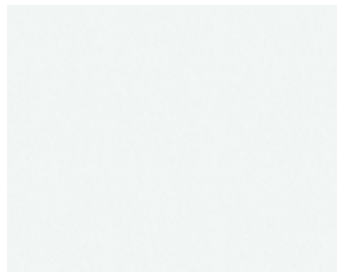

**B175R**  
Snow White - Matte

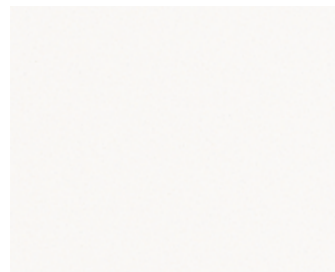

**B21R**  
White - Matte

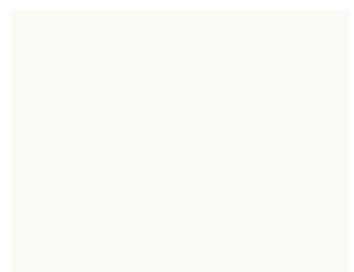

**C73R**  
Frosty White - Matte

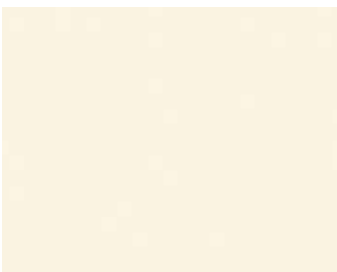

**V629R**  
Ivory - Matte

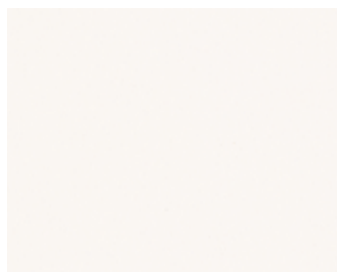

**C72S**  
Antique White - Satin

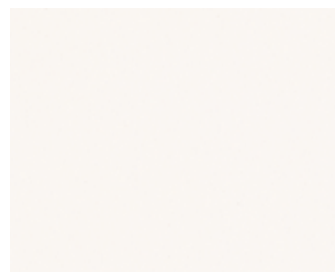

**C72R**  
Antique White - Matte

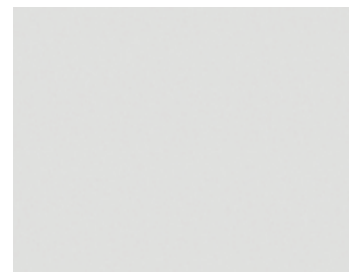

**R82S**  
White Smoke - Super Matte



**R663S**  
Morning Dew - Satin

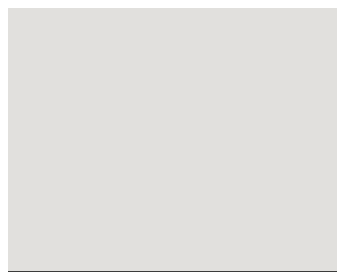

**H109L**  
Gray - High Gloss

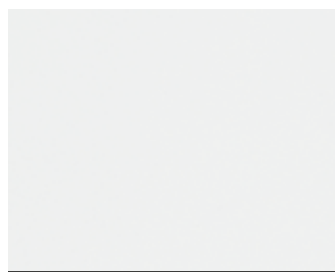

**V202S**  
Summer Drops - Satin



**K168S**  
Canadien Grey - Satin



**R660S**  
Rain Cloud - Satin



**R232S**  
Ashen - Satin

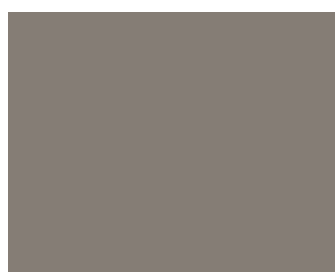

**K233S**  
Gountlet Grey - Satin



**R83S**  
Shipshaw - Super Matte

# COLORS AND FINISHES

---

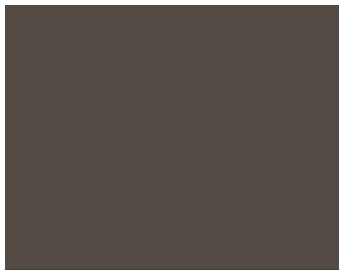

**K241S**  
Sienna - Satin



**A661S**  
Moon Light - Satin

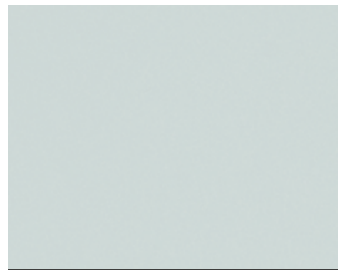

**K636S**  
Fjord - Satin



**K503S**  
Celadon Green - Satin



**K257S**  
Verde - Satin



**V731V**  
Matte Luxe Viridian - Velvet



**R237S**  
Charcoal - Satin

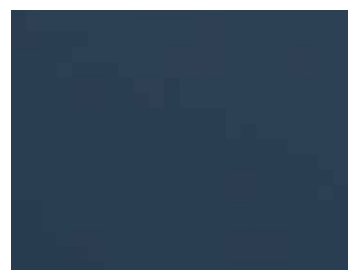

**K85S**  
Mysterious Blue - Satin



**R80S**  
Celestine - Satin



**K75S**  
Violet Grey - Satin

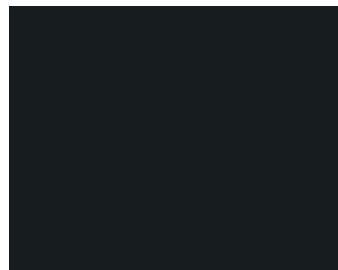

**P909R**  
Black - Matte

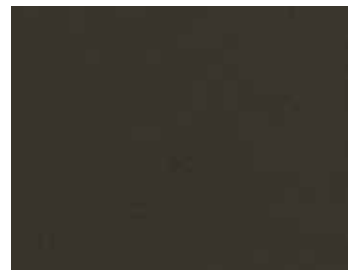

**V745V**  
Matte Luxe Black - Velvet



**R32S**  
Black - Super Matte

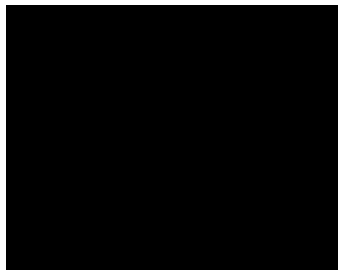

**R42L**  
Black - High Gloss

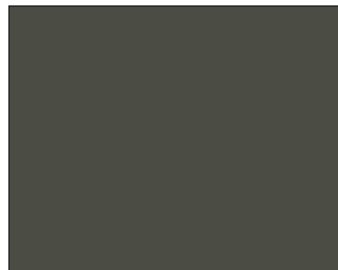

**H110L**  
Taupe - High Gloss

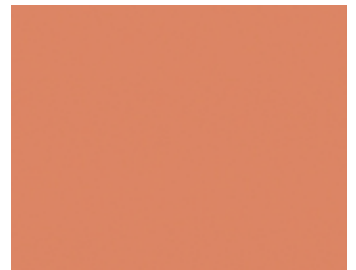

**R81S**  
Adobe - Super Matte



**K961R**  
Stainless Steel - Matte



**V285WT**  
Jazz Silk - Textured



**B54W**  
Designer White Woodgrain - Matte



**P492W**  
White Chocolate - Matte

# COLORS AND FINISHES

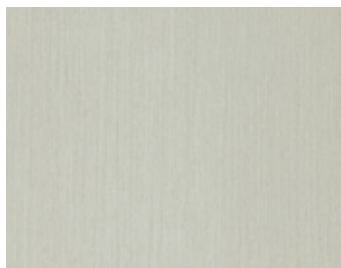

**D530WT**  
Latitude Nord - Textured



**A4WT**  
Winter Fun - Textured



**F432W**  
Taction Oak Alabaster - Satin



**A54WT**  
Skye - Textured



**A3WT**  
Weekend Getaway - Textured



**A61WT**  
Soie - Textured



**V66WT**  
Whisper - Textured



**K464WT**  
Nomade - Textured



**P340W**  
Aria- Matte



**V393WT**  
Concrete Groovz - Textured



**A60WT**  
Mousseline - Textured



**K02W**  
Sesame - Satin



**R89WT**  
Cosmos - Textured



**A15WT**  
Après-ski - Textured



**F435WT**  
Taction Oak Palomino - Textured



**V67WT**  
Rumour - Textured



**C92W**  
Hard Rock Maple - Matte



**F21W**  
Candlelight - Matte



**R205W**  
Tobacco Cherry - Matte



**P488W**  
Dolce Vita - Matte



# COLORS AND FINISHES

---



**A24WT**  
Dalia ambassador - Textured



**P489W**  
Copa Cabana - Matte



**F434WT**  
Taction Oak Gibraltar - Textured



**R207W**  
Choco Cherry - Matte



**R74W**  
Mahagony - Matte



**B44W**  
Chocolate espresso - Woodgrain



**P494W**  
Dark Chocolate - Matte



**R477W-DT**  
Tuxedo - Matte



**V392WT**  
Licorice Groovz - Textured



**P501WT**  
Linear Ash - Textured

CERTIFICATE OF  
WARRANTY

10 YEARS

APPLICABLE TO THERMOPLASTIC PRODUCTS  
Starting on January 1<sup>st</sup> 2011 (see conditions on reverse)

Distributor

Invoice #

Date of purchase



# CERTIFICATE OF WARRANTY

## 1. General Terms and Conditions

Prémoulé guarantees its thermoplastic products which are distributed and sold through an authorized distributor.

The installation should only be done by an experienced professional. It is also the responsibility of the person installing the product to determine its suitability for a particular application.

Prémoulé guarantees its products against yellowing, delamination or any apparent or hidden defect that might affect their quality or cause premature deterioration. The following conditions apply:

## 2. Duration

This guarantee is valid for a period of 10 years following the date of purchase.

## 3. Exclusions

This guarantee does not apply:

### 3.1 When damages are caused:

- by misuse or abuse of the product by the buyer
- by improper installation or exposure to the elements
- by any modification, transformation, or correction of the product without a written authorization from Prémoulé;
- by improper storage;
- by any indirect damage (including incidentals, special or consequential damages);
- by exposure to a temperature over 85 °C (185 °F)

### 3.2 To any deterioration of the product resulting from normal wear and tear.

### 3.3 To any damage or incident relating to the costs of installation and transportation, or any other costs relative to the application of this guarantee.

## 4. Scope

This guarantee is unassignable and constitutes the only guarantee offered by Prémoulé.

**There is no guarantee of merchantability or fitness for specific purposes other than the guarantee detailed above. Prémoulé makes no other guarantee whatsoever, expressed or implied, oral or written.**

## 5. Execution of Guarantee

For the duration of this guarantee, in order to exercise his rights, the buyer shall notify as soon as possible the authorized distributor or PRÉMOULÉ of any defect in the product and shall provide proof of purchase or the back of this present certificate properly completed. The buyer shall not make any repairs before the authorized distributor has had an opportunity to examine the product and its installation.

When this guarantee is applicable, Prémoulé may repair its products, provide replacement products or, at its sole option, offer the reimbursement of the purchase price.

## 6. Authorized Distributor

Only an authorized Prémoulé distributor may, in compliance with the terms and conditions of this guarantee, assume the obligations contained herein after obtaining prior authorization from Prémoulé. The authorized distributor is not mandated by Prémoulé to modify or extend the scope of this guarantee.

**Distributed by**

2375, avenue Dalton, bureau 200  
Québec (Québec) Canada G1P 3S3

**T** 418 652-7777 | 1 866 652-7777

**F** 418 652-7558 | 1 866 652-7558

**info@premoule.com**

**premoule.com**

Photography in this leaflet is for illustration purposes only. Actual color may vary slightly due to the printing process. For accurate color selection we recommend that you obtain a product sample.

Prémoulé supports

